

Demand Shocks, Procurement Policies, and the Nature of Medical Innovation: Evidence from Wartime Prosthetic Device Patents

Jeffrey Clemens and Parker Rogers*

August 4, 2022

Abstract:

We analyze wartime prosthetic device patents to investigate how demand shocks and procurement environments can shape medical innovation. We use machine learning tools to develop new data describing the aspects of medical and mechanical innovations that are emphasized in patent documents. Our analysis of historical patents yields three primary facts. First, we find that the U.S. Civil War and World War I led to substantial increases in the quantity of prosthetic device patenting relative to patenting in other medical and mechanical technology classes. Second, we find that the Civil War led inventors to increase their focus on reducing cost, while World War I did not. The Civil War era emphasis on cost is consistent with a role for that period's cost-conscious procurement model. Third, we find that inventors emphasized dimensions of product quality (e.g., a prosthetic limb's comfort or facilitation of employment) that aligned with differences in buyers' preferences across wars. We conclude that procurement environments can significantly shape the dimensions of the technical frontier with which inventors engage.

JEL Codes: H57, Procurement; I1, Health; O31, Innovation and Invention

*Clemens: University of California at San Diego, Economics Department, 9500 Gilman Drive #0508, La Jolla, CA 92093-0508. Telephone: 1-509-570-2690. E-mail: clemens.jeffrey@gmail.com. Rogers: University of California at San Diego, Economics Department, Econ 124, E-mail: parogers@ucsd.edu. We thank Joshua Chan and Yutong Wu for excellent research assistance. Many thanks to Guy Hasegawa for his generous assistance in sending us copies of archival materials used for his book "Mending Broken Soldiers." Thanks also to Rosemary Stevens and Rich Meckel for providing valuable perspective on the historical episodes we analyze. We also thank Dave Chan, Julie Cullen, Gordon Dahl, Michael Dickstein, Christian Dippel, Itzik Fadlon, Alex Gelber, Michela Giorcelli, Roger Gordon, Kate Ho, Neale Mahoney, Markus Nagler, Karthik Muralidharan, Elena Patel, Julian Reif, Kaspar Wuthrich, and seminar participants at the 2018 AEI Economists Roundtable, the 2019 Junior Health Economics Summit, the 2019 SIEPR Post-Doc Conference, the 2019 NTA Meetings, the 2020 Public Economics meeting at the NBER Summer Institute, the 2022 Campbell Fellows workshop on health economics at the Hoover Institution, the Ottawa Applied Micro Lab, Notre Dame, UNLV, and the Center for Economic Studies in Munich.

From 1960 to 2019, U.S. health spending rose from 5 to nearly 18 percent of GDP. Research has documented that the advance of medical innovation underlies a substantial share of this cost growth (Smith, Newhouse, and Freeland, 2009; Cutler, 2004), which raises a variety of questions. First, what factors drive the volume of medical innovation? Second, what leads inventors to focus on reducing costs (e.g., by streamlining production processes) versus improving quality? More generally, what factors shape the specific problems with which medical innovators choose to engage?

Wars and pandemics, among other events, can create acute needs for medical innovation. The COVID-19 pandemic, for example, generated demand for new vaccines, new diagnostic tests, testing infrastructure, and personal protective equipment. The value of new vaccines is widely recognized. Improvements in medical equipment, reductions in production costs, and expansions in productive capacity can also have substantial value when demand rises sharply. This motivates us to study how demand shocks and procurement environments shape the volume of medical innovation, its emphasis on the production process, and its emphasis on dimensions of product quality.

We analyze the effects of demand shocks and procurement environments on the quantity of medical innovation and the product and production process attributes it emphasizes. Our empirical analysis considers two important periods in the history of prosthetic device innovation: the U.S. Civil War and World War I. We begin by presenting key details of these historical contexts, including differences in demand, differences in procurement incentives, and differences in the stated goals of the public procurers. We show that both the Civil War and World War I led to substantial increases in prosthetic device patenting. A point of contrast is that the Civil War led to a much greater focus on cost-conscious innovation while World War I did not. To the best of our knowledge, this analysis provides the first evidence that cost-conscious procurement environments can indeed steer medical innovation in a cost-conscious direction.

Empirically assessing how incentives shape the emphases of inventors requires overcoming two primary challenges. First, existing data sources that categorize patents or clinical trials do not provide information on an invention's detailed economic attributes. Extracting this information requires going deeper into an invention's details. Second, linking procurement environments to the specific attributes on which inventors focus requires analyzing settings across which those environments exhibit variation.

To gain insight into how inventors advanced the frontier of prosthetic device technology, we use machine learning tools to construct a novel data set. We begin by closely reading 1,200 patents from the periods surrounding the U.S. Civil War and World War I. Our selection comprises prosthetic device patents and patents from other medical and mechanical technology classes. Based on these close readings, we code variables describing the economic traits emphasized in each patent. These variables include three traits that we interpret as production-process attributes, three traits that capture distinctive dimensions of product quality, and two additional traits that are less clearly defined as quality or production process traits. We then use machine learning tools to extend our data set to include a much larger set of patents.

The U.S. Civil War and World War I generated dramatic increases in demand for artificial limbs, as amputations were remarkably common. The associated public procurement environments created incentives that differed across the two wars. Our empirical analysis of these episodes includes a combination of time series and difference-in-differences methods. In the time series analysis, we directly examine changes in prosthetic device patents. In the difference-in-differences analyses, we use patents from other medical and mechanical technology classes to construct control groups.

Our first result quantifies the effects of the Civil War and World War I on the quantity of prosthetic device innovation. For several years during these historical episodes, prosthetic device patenting rose by nearly 100 log points relative to patenting in our control

groups. Despite analyzing only two events, the relative increases in prosthetic device patenting are strongly statistically distinguishable from zero. Our evidence from patents filed with the U.S. Patent and Trademark Office (USPTO) is supplemented by patents from the short-lived Confederate patent office, as well as from the British and Spanish patent authorities.¹

For the Civil War period, we have sufficient information to infer an elasticity of innovation with respect to potential revenues. We estimate an elasticity on the order of one for both patenting and firm entry; this is higher than typical estimates of long-run elasticities of medical innovation with respect to long-run changes in market size (Dubois, De Mouzon, Scott-Morton, and Seabright, 2015). Innovation may respond more rapidly to crisis-driven shocks than to standard changes in market size, as Agarwal and Gaule (2021) have observed in the context of the COVID-19 pandemic.

Second, we find that the demand shock associated with the Civil War generated substantial effort to reduce the cost of producing prosthetic devices. During the Civil War, the average prevalence of production process traits doubled in prosthetic device patents but was essentially flat within other technology classes. There was a far more modest shift towards production process traits during World War I. The Civil War era shift towards cost-oriented innovation is consistent with an important role for procurement incentives. As discussed in section 1, the U.S. government's Civil War era procurement program involved modest, fixed-price payments to artificial limb manufacturers, which can create strong incentives for innovation to reduce production costs.² As further suggestive evidence for the role of procurement incentives, we show that patents

¹In the British patent data, we see a large increase in prosthetic device patenting during World War I and no increase during the U.S. Civil War. Spain participated in neither conflict and the Spanish data exhibit no increase in prosthetic device patenting.

²With fixed prices set moderately below baseline costs, for example, sales are not profitable until manufacturers find ways to reduce production costs. More generally, even when the fixed price exceeds cost, a lower baseline profit per unit increases the returns to innovating to reduce cost relative to the returns to innovating to increase market share by increasing quality.

for artificial arms, for which profit margins were lower than for artificial legs, exhibit a more substantial shift in emphasis towards cost reduction during the Civil War.

Third, the prosthetic device patents of the Civil War and World War I diverged with respect to dimensions of quality. Civil War-era prosthetic device patents exhibit a substantial increase in emphasis on comfort. By contrast, World War I-era prosthetic device patents de-emphasize comfort and place greater emphasis on occupation-oriented “appliances.” The latter shift connects quite directly to the historical narrative, which highlights an emphasis of governments and medical professionals on the re-employment of veterans with amputated limbs. Civil War and World War I-era differences in emphasis on comfort are plausibly linked to a World War I-era shift in choice away from veterans and toward medical professionals. As detailed below, the historical narrative provides validation for the channels through which the Civil War and World War I-era procurement environments may have altered these dimensions of inventor effort.

Our analysis adds to a broad line of research on the effects of potential profits on innovation. This includes labor economics applications (Acemoglu, 1998; Hémous and Olsen, 2022) as well as a substantial environmental economics literature summarized by Popp (2010, 2019). In the context of health care, research on the effects of potential profits on innovation has focused primarily on pharmaceutical innovation (Finkelstein, 2004; Acemoglu and Linn, 2004; Budish, Roin, and Williams, 2015).³ Exceptions include analyses of medical equipment and device patenting by Clemens (2013) and by Galasso and Luo (2017, 2022).⁴ We contribute to this literature by providing novel evidence on

³Additional papers include Blume-Kohout and Sood (2013), who find that research on drugs with high Medicare market shares rose following the introduction of Medicare Part D, Yin (2008), who finds positive effects of the Orphan Drug Act, Dubois, De Mouzon, Scott-Morton, and Seabright (2015), who find that potential profits affect the number of new molecular entities that come to market, and Agarwal and Gaule (2021) who study medical innovation in the context of the COVID-19 pandemic.

⁴Clemens (2013) studies medical equipment patenting surrounding the introduction of Medicare. Galasso and Luo (2017) study the effects of tort reform on medical equipment and device innovation, while Galasso and Luo (2022) study the effects of liability risks faced by the suppliers of medical implants.

the effects of large demand shocks on prosthetic device innovation. We additionally provide evidence that innovation may respond more aggressively to crisis-driven shocks than one would infer on the basis of long-run elasticity estimates.

We also contribute to the literature on medical innovation by applying text analysis methods to gain insight into innovators' emphases on cost versus dimensions of product quality. Analyses of patent texts have become increasingly common in the innovation literature.⁵ We apply text analysis methods to develop the novel data required to make progress in understanding whether procurement environments can shape the particular dimensions of the technical frontier on which inventors focus. Methodologically, we develop several practical insights into best practice methods for this class of machine learning applications. The substance of our findings provides evidence that cost-conscious procurement environments can indeed steer medical innovation in a cost-conscious direction.

The paper proceeds as follows. Section 1 provides historical background and section 2 summarizes the hypotheses that are motivated by our historical settings. Section 3 discusses our novel data set and section 4 our empirical strategy. Section 5 presents our results and section 6 concludes.

1 Civil War and World War I Demand for Artificial Limbs

The U.S. Civil War and World War I were both associated with dramatic increases in demand for prosthetic devices. In this section, we begin by describing the size of these demand shocks. We then provide background on the relevant systems for rehabilitating veterans and procuring artificial limbs.

⁵See, for example, Khoury and Bekkerman (2016); Bergeaud, Potiron, and Raimbault (2017); Iaria, Schwarz, and Waldinger (2018); Watzinger and Schnitzer (2019); Arts, Cassiman, and Gomez (2018); Cockburn, Henderson, and Stern (2018).

1.1 The Magnitude of Wartime Demand Shocks

The U.S. Civil War was contested between the armies of the Union and the Confederacy from April 1861 to May 1865. An estimated 35,000 veterans with amputated limbs survived the war on the Union side alone (Linker, 2011, p. 98). Because the government had not formed a permanent bureaucracy for addressing veteran health care needs prior to the war, both the Union and Confederacy implemented ad hoc artificial limb procurement systems as the scope of need became clear. Wartime production levels (Barnes and Stanton, 1866; Hasegawa, 2012) far exceeded pre-war production as documented in the 1860 Census of Manufacturing. In developing our evidence of the effects of Civil War-era demand on innovation, we draw primarily on patents filed with the USPTO, but also consider patents filed with the short-lived Confederate patent office.

World War I produced an estimated 300,000 veterans with amputated limbs worldwide. Relative to the Civil War, demand associated with 4,000 U.S. veterans was relatively modest. Because production capacity was low among the European powers and high in the United States, the U.S.-based artificial limb industry played an important role in satisfying global demand. Great Britain, for example, which was home to an estimated 41,000 surviving veterans with amputated limbs (Guyatt, 2001, p. 98), invited the largest American prosthetic companies “to set up workshops at the main amputee center” (Linker, 2011, p. 99). In developing our evidence of the effects of World War I-era demand on innovation, we study patents from both the United States and Great Britain.

1.2 Background on Civil War and WWI-Era Procurement

During the Civil War, the manufacturers of artificial limbs faced a competitive environment in which they were reimbursed on a “fixed-price” basis. To become eligible for purchase through the Union’s limb allowance program, artificial limb models had to be

certified by a board of physicians.⁶ If the board deemed a prototype to be “serviceable,” its manufacturer entered the list of manufacturers from which soldiers could select the provider of their artificial limb. Fixed-price reimbursements were set at modest levels relative to manufacturers’ stated costs from the pre-war period, and balance billing was prohibited (Hasegawa, 2012, p. 37-38).⁷

By World War I, the U.S. had substantively formalized the treatment of veterans with amputated limbs. This occurred within a broader effort to formalize veterans’ health care. In addition to being formalized, care for veterans with amputated limbs was mostly centralized at large facilities, including the recently built Walter Reed Hospital.⁸

Progressive Era policymakers worried that veterans with amputated limbs would, like many of their Civil War predecessors, fail to return to gainful employment. A perception of limbless Civil War veterans “pocketing” their allowances and opting out of the labor force impacted World War I-era views regarding care and rehabilitation (Linker, 2011). As Linker (2011, p. 13) writes, “The veterans of America’s First World War were expected to become citizen-workers once their military service was over; they were to make useful lives, not to languish at the expense of the US Treasury.”

Between the Civil War and World War I, discretion in the choice of artificial limb shifted from veteran to government. During World War I, veterans underwent extensive

⁶As Hasegawa (2012) documents, General William Hammond convened a panel of physicians to, in Hammond’s words, “determine what kind of Artificial Limbs should be adopted for the use of mutilated soldiers.”

⁷During the latter half of the war, the price for artificial legs was set at \$75 (roughly \$1,500 in 2018 dollars) and the price for artificial arms was set at \$50. A small number of products were authorized for sale at higher rates (Hasegawa, 2012, p. 40). In such cases, the veteran was responsible for the difference between the approved price and the government’s allowance of \$75 per leg or \$50 per arm. These products were meant to be sold at the approved prices on a fixed rate basis with no balance billing. Hasegawa (2012) documents that a leading manufacturer told the government his costs were \$150 per artificial leg.

⁸Treatment of veterans with amputated limbs also took place at Letterman hospital in San Francisco. As Linker (2011, p. 80) writes, “Surgeon General Gorgas designated two general hospitals to become permanent installations for rehabilitative care: Letterman General Hospital in San Francisco and Walter Reed General Hospital in Washington. Later in the war, the list of military rehabilitation hospitals would grow to 14, but Letterman and Walter Reed remained the flagship facilities during and after the war.”

rehabilitation prior to their return to civilian life, including obligatory use of standard-issue prosthetic limbs. Linker (2011, p. 101) writes that “the OSG [Office of the Surgeon General] forcefully mandated artificial limb wear, creating legislation that made it virtually impossible for US amputee soldiers to be discharged from military service without months of rehabilitation and daily routine artificial limb wear.” In contrast with the Civil War, demand for artificial limbs was thus shaped to a significant degree by the veterans’ medical bureaucracy and to a lesser degree by wounded veterans.

The incentives facing artificial limb manufacturers were shaped by the preferences of World War I-era medical bureaucracies in both the U.S. and Europe. While we cannot know the precise criteria each bureaucracy used in their procurement of artificial limbs, the historical record provides clues regarding approaches to rehabilitation. Medical professionals of the World War I-era de-emphasized comfort in favor of a strict rehabilitation program. Linker (2011, p. 109-114) writes, for example:

Once surgical healing had been attained... the ‘toughening’ of the stump by ‘pounding it on a firm surface’ should be ‘vigorously pursued’... Following stump pounding exercises, ‘patients usually complained of discomfort’... Another report stated that when amputees were forced to wear artificial limbs soon after surgery, they often ‘expressed gratitude when the artificial limb [was] removed.’

In addition to driving a relatively severe program of physical rehabilitation, the desire for social reintegration spurred an emphasis on re-employment. The British government had similar views on the importance of rehabilitation and re-employment.⁹ The historical record thus suggests that World War I-era procurers placed substantial emphasis on artificial limbs’ capacity to restore an individual’s employability.

⁹See, for example, the discussions of British World War I-era rehabilitation and artificial limb manufacturing in Novotny (2017) and Guyatt (2001).

2 Implications of Wartime Demand Shocks for Innovation

We draw on the historical narrative regarding Civil War and World War I-era demand shocks and procurement environments to develop hypotheses regarding the potential effects of these events on prosthetic device innovation. The hypotheses motivated by the historical record are as follows:

First, the large demand shocks associated with both the Civil War and World War I increased incentives for developing novel prosthetic devices. The hypothesis that these demand shocks would increase flows of innovation is perhaps the most standard hypothesis in the literature on demand-driven innovation.

Second, the Civil War-era procurement environment featured a low, fixed-price reimbursement regime. We hypothesize that this regime may have generated an increase in inventor emphasis on cost-conscious innovation. This hypothesis is linked in part to the fact that production costs must be driven below the reimbursement level before sales become profitable.

Third, we hypothesize that the emphasis of World War I-era procurers on the re-employment prospects of wounded veterans may have increased inventor emphasis on the capacity for artificial limbs to enhance their wearer's social reintegration and employability. Social reintegration could be facilitated by limbs that more faithfully mimicked the appearance of a natural limb. Employability could be facilitated by a line of artificial limb technology we call "appliances." In this context, the word "appliances" refers to interchangeable artificial limb attachments which serve functions that connect directly to occupational tasks.

Fourth, we hypothesize that the Civil War-era procurement environment may have increased inventors' emphasis on characteristics demanded by veterans, who could choose across products, while the more centralized World War I-era procurement environment prioritized the preferences of the veterans' medical bureaucracy. This final hypothesis

has less precise empirical content than hypotheses one through three. It may be relevant to such traits as an artificial limb’s comfort and appearance.

3 Patent Data and Text Analysis Methods

We begin this section with a discussion of the historical patent data we use to estimate the effects of wartime demand shocks on overall patent flows. We then discuss the new data we generated through text analysis (or natural language processing) using a combination of close readings and machine learning techniques.

3.1 Historical Patent Data

The first question we attempt to answer is if wartime increases in demand for prosthetic devices increased the rate of prosthetic device patenting. This analysis requires information on 19th and early 20th century patents by technology class. Until relatively recently, the patent data sets analyzed by economists did not facilitate this type of historical analysis. The groundbreaking NBER patent database (Hall, Jaffe, and Trajtenberg, 2001), for example, begins with patents granted in 1963. Economists have recently developed databases extending to the earliest surviving records of the U.S. Patent and Trademark Office (USPTO). To identify historical patents based on their technology classes, we use the database assembled by Berkes (2018).¹⁰ We supplement these data with additional data on Confederate patents, British patents, and Spanish patents.¹¹

One shortcoming of the Civil War era patent data is that, before 1873, patents reported the date the patent was issued, but not the date it was filed (Berkes, 2018). Conse-

¹⁰In a comparison of several recent efforts to compile data sets on the universe of U.S. patents, Andrews (2019) concludes that the database laid out in Berkes (2018) is “currently the gold standard.” Additional analyses of 19th and early 20th century patents, including those by Berkes and Nencka (2019) and Berkes, Gaetani, and Mestieri (2019) have been made possible by these data.

¹¹Sáiz (2000) and Sáiz, Llorens, Blázquez, and Cayón (2008) generously provided Spanish patent data.

quently, we organize patents according to their date of issuance throughout our analysis. Patents from 1873 onward allow us to gauge the typical lag between patent filing and issuance during the period we analyze. From 1873 through the end of our World War I sample, the average lag between filing and issuance was 1.2 years for the full set of technologies we analyze and just over 0.9 years for prosthetic devices.¹² We test whether indexing by patent issuance dates changes our findings relative to indexing by filing dates using data from the World War I era. We find that the time series for both our treatment and control classes are shifted forward by roughly one year when indexed by patent filing year, as shown in panels A and B of Figure D.6. This has little influence on our reading of the evidence.

Figure 1 provides an initial look at time series on prosthetic device patents and other broad categories of patents during the historical episodes we analyze. The dashed vertical lines in each panel encompass the years we subsequently associate with war-induced booms in prosthetic device patenting. It is quite clear from the panels of Figure 1 that both the Civil War and World War I were associated with substantial increases in the rate of prosthetic device patenting among combatant nations (i.e., the United States during the Civil War and World War I, the Confederacy during the Civil War, and the United Kingdom during World War I), but not among non-combatant nations (i.e., the United Kingdom during the U.S. Civil War and Spain during both the U.S. Civil War and World War I). However, quantifying the causal effect of wartime demand shocks requires constructing counterfactuals, which we discuss in section 4.

There are limitations when using patent counts to measure innovation. Primarily, patent counts do not necessarily measure changes in meaningful innovation. Thus, during the period surrounding World War I, we follow standard practice in the literature by

¹²In the technology classes we analyze, the average lag between filing and issuance has exceeded three years during the 21st century. Lags between filing and issuance have thus been much longer in recent years than during our sample.

using citations as a proxy for patent quality. As shown in Panel B of Figure D.4, the average number of citations per patent was fairly stable during World War I, suggesting that the prosthetic device patent boom was associated with patents of similar impact as the pre-war patents. Citation measures of quality for Civil War patents are less reliable. As described by Berkes (2018), 19th-century patents have less complete and noisier citation data. Panel A shows that, during the Civil War period, the sparsity of citation data likely renders this exercise uninformative. To validate the quality of Civil War era patents, we look to information reported in Tables 1 and 2, which we describe below in detail.

Several features of the Civil War period allow us to establish that changes in patenting connect to real industry responses. The most striking point is that we directly observe the entry of new manufacturers. Further, as reported in Table 1, we are able to establish links from patents to manufacturers, from manufacturers to sales through May 1866, and from both sales and manufacturers to expert assessments of quality.¹³ Twelve out of the thirteen most notable manufacturers of artificial legs and eight out of the nine most notable manufacturers of artificial arms from the Civil War period can be linked to at least one patent. Through May 1866, these patent-holding manufacturers accounted for nearly all of the artificial legs and nearly 90 percent of the artificial arms furnished to Union Army veterans. As shown in Table 2, contemporaneous sources reveal a dramatic increase in the number of artificial limb manufacturers, artificial limbs produced, and the total value of artificial limb output during the U.S. Civil War. Finally, medical histories document that these episodes were, in fact, episodes of substantial advance in artificial limb technologies.¹⁴

¹³A limitation of this analysis is that we can only estimate market shares for the 6,075 artificial limbs documented in Barnes and Stanton (1866). Because this memorandum was submitted on May 11, 1866, it cannot document market shares for artificial limbs delivered after that time.

¹⁴Post- and late-war rankings of artificial limbs by quality further support a link between quality and market share (Barnes, 1865; Houston and Joynes, 1866). The top three rated artificial legs accounted for just under 60 percent of sales through May 1866, while the top four rated artificial arms accounted for just over 60 percent of sales through May 1866. The highly-rated limbs with low market shares were those

3.2 Coding Patent Attributes

Beyond measuring patent flows, our analysis aims to understand the economic attributes that are emphasized in each patent. We pursue this to understand how inventors distributed their efforts across improving aspects of production processes and/or particular dimensions of each product's quality. Because the data required for this analysis did not previously exist, we developed a novel data set.

Our data set contains information that quantifies the economic attributes emphasized in historical patent documents. To generate this information, we first created a program to scrape historical patent documents from Google Patents. Using the text of each patent document, we then coded a set of product and/or production process attributes on which the patent places emphasis. We describe three of these attributes, namely cost, simplicity, and adjustability, as cost-oriented production process traits. That is, these traits involve aspects of a product's production. We use the term "adjustability," for example, to describe patents that emphasize uniform production of outputs that can subsequently be fitted (or "adjusted") to the needs of a specific consumer. Three traits, namely comfort, appearance, and occupation-oriented appliances, are quality-oriented attributes. We also code two additional traits, namely materials and durability, that we have not explicitly labeled as either product or production-process traits.

Table 3 presents a concise verbal definition of each economic attribute. The table also summarizes three important aspects of each attribute related to the quality of the information we capture with each variable. The first aspect, summarized in column 3, is the strength of the linkage between each trait and the hypotheses we have generated based on the historical record (i.e., the hypotheses laid out in section 2). The second

developed relatively late during the war, namely the artificial arms of John Condell and the National Arm and Leg Company. The low market shares we observe for these limbs in sales through May of 1866 are thus largely mechanical, as they were not on the market when most of the limb purchases for which we have documentation occurred. Low-rated limbs with non-trivial market share tended to be either unpatented or to involve pre-war patents, suggesting an incumbency advantage.

aspect, summarized in column 4, is our assessment of the extent to which our text analysis procedure generated a variable that successfully captures the economic content we sought to capture. The third aspect, summarized in column 5, is our assessment of the challenges associated with identifying comparison technology classes to construct control groups for our analysis of a given trait.

How successfully can the variables we generate capture the intended economic content of patents? A key point regarding this important methodological question is that the difficulty of identifying economic concepts in text can vary substantially from concept to concept. In the remainder of this section, we illustrate the underlying issues with a small number of examples. Appendices A and B provide substantially more detail.

Some economic concepts are straightforwardly conveyed in text. We found this to be true, for example, of the traits cost and simplicity. One patent, for example, describes the mechanism underlying an artificial knee joint as having “great simplicity, and therefore cheapness.” A second states “The object of my invention is to imitate this eccentric motion of the knee-joint in the simplest manner.” For both simplicity and cost, there is little difference between the performance of our close readings, our fully refined machine learning model, and a straightforward keyword search.

Other concepts are more inherently difficult to track in text than cost or simplicity. Tracking the use of new materials, for example, proved difficult because establishing a set of keywords requires knowing what materials are common and what materials are newly introduced in manufacturing products in a given technological class. These difficulties are sufficiently severe that we place little emphasis on our findings for the “materials” trait.

Other traits can capture clear and distinctive technological developments despite being very specific to a particular technological class. The trait we term “appliances” exemplifies this third scenario. As illustrated through a set of examples, occupation-oriented

“appliances” were a critical, clearly defined dimension of prosthetic device innovation during World War I. This dimension of prosthetic devices, however, does not have a strong analogy in other technology classes. This fact casts doubt on the potential utility of constructing a control group for analyses of such a trait, as conveyed by our designation of appliances as “weak” in column 5 of Table 3. For a trait like “appliances,” evidence from simple time series differences may be more informative than analyses that incorporate counterfactuals based on other technology classes.

3.3 Text Analysis

This section provides an overview of the text analysis tools we developed and implemented. Appendix B describes these tools in greater detail and underscores several best practices to consider when generating variables with machine learning algorithms.

Our text analysis methods can be concisely described as the output of a keyword search that has been informed by domain-specific knowledge and enhanced by machine learning tools. We developed domain-specific knowledge by closely reading just over 1,200 patent documents. While reading these patents, we completed two tasks. First, we form the data set to train our machine learning model by indicating whether each patent has specific attributes. Second, we construct the initial sets of keywords that we associate with each of the attributes.

The set of closely-read patents (i.e., the “training set”) covers the domains relevant to our analysis. That is, our training set includes patents from both the prosthetic device class and candidate control classes, as well as from both the Civil War and World War I-eras. To achieve this coverage, we randomly selected our sample of closely-read patents after stratifying across technology classes and war episodes. As summarized in Table D.2, the manually coded data set contains 195 prosthetic device patents and 399 other medical or mechanical patents from the Civil War period, as well as 302 prosthetic device

patents and 305 other medical or mechanical patents from the World War I period.¹⁵

Our text analysis task faces a common problem of dimensionality. With just over 1,200 patents in our training set, algorithms will perform poorly if we attempt to use every word from every patent document as an input. We thus implement an approach to limit the algorithm’s attention to the most relevant words, or “features,” in each patent document’s text.¹⁶ The features we selected are a set of keywords, synonyms, and a small neighborhood of textual context surrounding the keywords and synonyms (see appendix B for more details). We developed our initial lists of keywords based on our 1,200 closely read patents. We next augment these keywords with synonyms that appear in similar linguistic contexts, which we selected using the “Word2Vec” algorithm (Mikolov, Sutskever, Chen, Corrado, and Dean, 2013). Finally, to aid our algorithm in identifying context-specific word meanings, we gather a “spread” of contextual words surrounding the appearance of each keyword. Our augmented set of keywords and their accompanying contextual “spread” are the features from each patent that we use as inputs into our machine learning model. After training and validating our model, we use the model to extend our encodings to roughly 750,000 patent texts that span our treatment and control groups.

3.4 Novel Data Set on Patent Attributes

Our final data set, produced by our machine learning approach, describes the economic attributes of 745,558 patents, with the earliest coming from 1840 and the latest

¹⁵The attribute “appliances” is an exception. The relevance of occupation-oriented appliances was drawn to our attention by a referee in August 2021, which was several years after we completed the close readings underlying the coding of other traits. Our coding of appliances is thus based on a keyword search that is informed by close readings of a smaller number of patents.

¹⁶This approach, which is called “feature selection,” has been shown to improve the efficiency of predictive models (Guyon and Elisseeff, 2003). The familiar Lasso procedure, for example, limits the number of features in the model by applying a penalty factor within its objective function.

from 1940. There are 814 prosthetic device patents, 19,666 other medical patents, and 725,078 mechanical patents. Our regression analyses focus on samples of our 745,558 patents for which the patent year is in relatively close proximity to each conflict. These samples extend from 1855 to 1867 and from 1910 to 1922.

Across this large set of patents, appendix Table D.4 shows that the economic traits we coded are only modestly correlated with one another. The primary exceptions are cost and simplicity. Among prosthetic device patents, cost and simplicity share a correlation of 0.378 with an associated r-squared of 0.142. Similarly, across all patents in our data set these traits share a correlation of .303 with an associated r-squared of 0.092. Correlations across all other trait pairs are between -0.12 and 0.13, highlighting that the traits capture independent dimensions of innovation.

4 Empirical Strategy

We now present our specifications for analyzing changes in patenting rates and in the economic characteristics emphasized in patent documents. After presenting each estimation framework, we highlight the key challenges we face when attempting to generate causal estimates of the effects of wartime demand shocks.

4.1 Analyzing Patent Counts

We begin by estimating the effects of the Civil War and World War I on patent counts using the regression equations below. The first is specified as an Ordinary Least Squares model for predicting the log of patents per year:

$$\ln(N_{t,c}) = \alpha_{c,w(t)} + \alpha_t + \beta_1 1\{\text{War}\}_t \times 1\{\text{Prosthetic}\}_c + \epsilon_{c,t}. \quad (1)$$

The second is specified as a Poisson model of patent counts:

$$E[N_{t,c}|X_t] = \exp(\gamma_{c,w(t)} + \gamma_t + \beta_1 1\{\text{War}\}_t \times 1\{\text{Prosthetic}\}_c + \varepsilon_{c,t}). \quad (2)$$

In both equation (1) and equation (2), c denotes patent classes, t denotes time (multi-year time periods for these specifications), and $w(t)$ denotes war episodes (Civil War and World War I). $N_{t,c}$ denotes the number of patents in class c at time t . The specifications include time fixed effects (α_t or γ_t) and episode-by-patent class fixed effects ($\alpha_{c,w(t)}$ or $\gamma_{c,w(t)}$). The coefficient of interest is β_1 , which is an estimate of the differential change in the patenting rate for prosthetic devices relative to the control classes during war episodes relative to pre-war periods. The periods over which the wars influenced prosthetic device patenting are defined to extend from 1862 to 1866 for the Civil War and from 1916 to 1922 for World War I.

The key challenge in developing causal estimates is to construct control groups that approximate the counterfactual development of patenting rates for prosthetic devices. Technology classes might generate inappropriate counterfactuals for a variety of reasons. They might, for example, be affected by very different sets of scientific developments (e.g., nuclear technology vs. prosthesis). Alternatively, a plausibly comparable technology class will be a poor control class if it is directly affected by wars (e.g., firearms) or if it is shaped by spillovers from prosthetic device innovation.

Our selection of a complementary set of control groups follows the logic of Finkelstein (2004), whose analysis of vaccine clinical trials is analogous to our setting in some key respects. The patents we use to construct control groups come from broad categories of medical and mechanical innovations. In all analyses, we exclude technology classes for which there was one or fewer patents per year within the time periods into which we divide the data. Our largest control group incorporates all medical and mechanical technology classes that meet this criterion. We also consider sub-groups chosen to either increase comparability or reduce the likelihood that the control group contains

patent classes that could be directly affected by the wars. Like Finkelstein (2004), we also consider data-driven control groups. For our analysis of patent flows, the data-driven approach selects the control group to match baseline flows of prosthetic device patents in levels.

4.2 Analyzing Patent Traits

Our analysis of the traits emphasized by wartime prosthetic device patents confronts challenges that differ from the challenges facing our analysis of patent counts. The variables of interest in this analysis describe the share of patents within a given technology class and time period that emphasize the characteristic of interest:

$$\text{Category Trait Share}_{period} = \frac{\# \text{ Category Patents with a Trait}_{period}}{\# \text{ Category Patents}_{period}}.$$

For our analysis of patent traits, it is less clear what might constitute a reasonable control group. It may simply be less relevant, for example, to worry that the traits emphasized by prosthetic device patents will shift markedly for reasons unrelated to the wartime demand shocks on which our analysis focuses. As an initial estimator, this leads us to consider simple time series changes among prosthetic device patents:

$$\beta^{TS} = [\text{Prosth. Trait Share}_{wartime} - \text{Prosth. Trait Share}_{prewar}] \quad (3)$$

This is captured by β^{TS} from equation (3).

We also consider difference-in-differences estimates, which net out changes in the emphasis on a given trait among the patents within a control group. For analyses of this sort, selecting control groups is non-trivial because some traits of interest are only

relevant to a small set of the technology classes within our broadest control group. As shown in Table D.3, for example, this is true of traits including “appearance” and “comfort.” This leads us to select control groups using several complementary approaches, which include the construction of synthetic control groups as well as a simple matching procedure.¹⁷ We discuss additional aspects of our application of the synthetic control procedure in Appendix C. The resulting estimator takes the form below:

$$\begin{aligned} \beta^{DD} = & [\text{Prosth. Trait Share}_{\text{wartime}} - \text{Prosth. Trait Share}_{\text{prewar}}] \\ & - [\text{Other Trait Share}_{\text{wartime}} - \text{Other Trait Share}_{\text{prewar}}], \end{aligned} \quad (4)$$

We interpret our findings as being robust if we obtain similar results whether we rely on the time series variation, as in equation (3), or any of several plausible difference-in-differences strategies, as in equation (4).

5 Results

This section presents estimates of equations (1), (2), (3), and (4). Subsection 5.1 presents estimates of the effects of the Civil War and World War I demand shocks on flows of prosthetic device patents. Subsection 5.2 discusses the magnitudes of our estimates. Subsections 5.3 and 5.4 present estimates of changes in the attributes emphasized in prosthetic device patents during the wartime patent booms relative to the pre-war periods.

¹⁷When implementing the synthetic control approach for our Civil War sample, patent flows for many technology classes were limited, including prosthetic devices. In each of 1858 and 1861, for example, there was a single prosthetic device patent. The maximum across the pre-Civil War years was seven, which occurred in 1859. The share of patents emphasizing a given trait is thus highly volatile across the Civil War baseline when expressed at an annual frequency. Matching year-to-year trends would amount to matching noise. For our baseline method, we thus match levels and trends in four-year moving averages. As a natural robustness check, we have confirmed that our results are little changed by matching levels and trends on either three-year moving averages or five-year moving averages.

5.1 Overall Patent Flows

Table 4 presents estimates of equation (1). The estimates presented across the columns differ exclusively with respect to the patent classes used as controls. The estimate in column 1 reveals that wartime changes in prosthetic device patenting were roughly 95 log points larger than changes in patenting in all other medical or mechanical patent classes. Columns 2 through 7 reveal that this estimate is only moderately sensitive to using subsets of the broader set of controls. The subsets include other categories matched based on baseline patenting rates (column 2), other medical categories only (column 3), the “miscellaneous” mechanical classes (column 4), metalworking mechanical classes (column 5), materials processing mechanical classes (column 6), and all classes except those that would be plausibly affected by wartime demand shocks (column 7).¹⁸ The estimates range from 85 log points to 102 log points. Panels B and C reveal substantial increases in prosthetic device patenting during each war episode, with economically larger increases occurring during the Civil War than during World War I.

Appendix D provides additional evidence relevant for interpreting these findings. First, Table D.1 presents estimates of the Poisson model described by equation (2). Second, Figure D.1 presents an “event study” analysis, which provides evidence against the concern that wartime increases in prosthetic device patenting were driven by pre-existing trends. Third, Figure D.2 illustrates why, despite having only two class-by-time period treatment events, the wartime increases in prosthetic device patenting are nonetheless

¹⁸Our restriction of the control group to other medical technology classes (column 3), is similar to the approach taken by Moser, Voena, and Waldinger (2014) in their analysis of chemicals patenting. We obtain similar, though modestly smaller, results when further narrowing our control group to the sub-category “Miscellaneous-Drugs and Medicine,” which also contains Prosthesis innovation. This sub-category is quite small during these periods, however, as it comprises only two other classes, namely “Optics: Eye Examining, Vision Testing and Correcting” and “Dentistry.” A further issue facing this approach to selecting control classes is that optics and dentistry are medical categories for which it is plausible that the Civil War and World War I may have had a direct effect. This may contribute to why we obtain moderately smaller point estimates when using these control classes rather than a broader control group. For details, we refer readers to the descriptions of the technology classes that are available on the website for the NBER patent database: <http://www.nber.org/patents/>.

strongly statistically distinguishable from zero when we conduct inference using “randomization tests” (Imbens and Rosenbaum, 2005). Each observation underlying Figure D.2’s histograms represents the change in patenting in a patent class in our broadest control group. The dashed vertical lines are placed at the value of the change for prosthetic devices. In the Civil War histogram (Panel A), the change in prosthetic device patenting is the rightmost point in the distribution; this underlies the uniformly low p-values in Panel B of Table 4. The change during World War I is quite close to the right end of the distribution (Panel B). Figure D.3 presents the results of the randomization inference procedures we implement, which are described in greater detail in the appendix.

5.2 Interpreting Magnitudes

The estimates in Tables 4 and D.1 capture the short-run responsiveness of patent flows to large shocks to market size. The magnitudes of both the shock and industry response are more readily translated into elasticities in the context of the Civil War than in the context of World War I.¹⁹ Between data from Barnes and Stanton (1866), Hasegawa (2012), and the 1860 Census of Manufacturers, we can infer that the Civil War elevated annual revenues across the artificial limb industry by an average of roughly 100 log points over four years.²⁰ The estimates in Panel B of Table 4 thus suggest that, during the Civil War, the elasticity of short-to-medium run patenting with respect to the short-

¹⁹It is less feasible to infer elasticities for the World War I period due to a combination of conceptual hurdles and data limitations. The key conceptual hurdle is that the conflict’s global nature makes it difficult to infer the precise markets to which the firms who were patenting with the USPTO were responding. The key data limitation is that we lack sources on the number of manufacturers either during or preceding the war. In the 1910 Census of Manufacturing, for example, artificial limb manufacturers have been merged with a broader category including surgical appliances.

²⁰From the 1860 census of manufacturers, we know that the value of the industry’s output was roughly \$53,000 in 1859. From Barnes and Stanton (1866), we know that over the first four years of the Union Army’s artificial limb program, an average of roughly \$91,000 in artificial limbs were procured. Viewing this as an increase over baseline demand from causes outside of the war, we estimate a 100 log point increase by comparing $\ln(53,000)$ to $\ln(53,000 + 91,000)$. The increase in units sold exceeded the increase in revenues because the Civil War limb allowances were substantially lower than pre-war prices.

to-medium run shock to potential revenues was slightly greater than 1. We can similarly infer an elasticity of firm entry with respect to the Civil War era demand shock. As reported in Table 2, there were five artificial limb manufacturers in the 1860 Census of Manufacturing, and at least 17 manufacturers in 1865, implying an increase of at least 120 log points. This implies an elasticity of firm entry of greater than 1. These elasticity estimates are larger than typical estimates of the long-run effects of potential market size on innovation, as discussed by Dubois, De Mouzon, Scott-Morton, and Seabright (2015). Consistent with recent findings from Agarwal and Gaule (2021), who analyze the COVID-19 context, we find relatively sharp short-run responses of innovation to crisis-driven demand shocks.

Interestingly, wartime booms in prosthetic device patenting were not sustained over the long run. This might initially seem puzzling, given that the government's commitment to providing limbs was ongoing. Historical context provides evidence, however, that sustained demand for U.S.-manufactured prosthetic limbs was short-lived during both episodes. Following World War I, demand for U.S.-manufactured devices was short-lived because the European powers made conscious efforts to develop their own prosthetic device industries. By 1920, moreover, veterans with amputated limbs in Germany, Canada, and the United States were documented to prefer adapting to life without a prosthetic (Linker, 2011, p. 114,118). The same was true following the Civil War; an overwhelming majority of Union veterans chose cash over replacement artificial limbs when they were given that choice during the post-war years.²¹ Substantial demand for

²¹Over the decades immediately following the Civil War, the U.S. government provided allowances for the regular replacement of artificial limbs. Notably, veterans were allowed to choose between a replacement limb and cash, which was referred to as a commutation payment (Hasegawa, 2012, p. 76). Statistics from annual reports of the army's Surgeon General reveal that veterans overwhelmingly preferred cash; from 1870 to 1891, "arm amputees chose a new device over commutation only 1.4 percent of the time, and leg amputees selected a new leg 21.9 percent of the time" (Hasegawa, 2012, p. 76). This suggests, perhaps unsurprisingly, that quality was low in an absolute sense. The shock to artificial limb purchases was thus a pronounced shock spanning a period of four to five years. Our estimates will thus tend to capture the short-to-medium response of industry to a large but temporary shock to demand.

replacement limbs thus may not have materialized. In both settings, the preference for cash over replacement limbs is suggestive that, contemporaneous innovation notwithstanding, quality remained low in an absolute sense.

5.3 Traits of Wartime Prosthetic Device Patents

We now turn to estimating the effects of wartime procurement on the economic characteristics of prosthetic device patents. Our estimates of equations (3) and (4) are presented in Table 5, while the underlying time series are presented in Figures 2 and 3, with additional detail in Appendix Figures D.7, D.8, D.9, D.10, and D.11. Several facts of interest emerge from this analysis.

We find that the Civil War was associated with across-the-board increases in emphasis on our cost-oriented production process traits. The average across these traits (namely “cost,” “simplicity,” and “adjustability”) more than doubled from a base of 0.16, as shown in Figure 2. This estimate is statistically distinguishable from zero at the 0.01 level using either the simple time series or synthetic control estimator, as it is a true outlier relative to the distribution of randomization test outcomes. In contrast, the average across cost-oriented production process traits moved quite modestly during World War I. While both periods ushered in substantial increases in emphasis on adjustability, Civil War-era prosthetic device patents also exhibit economically substantial shifts towards emphases on “cost,” and “simplicity” as shown in Figure 3. Changes in the latter two traits were relatively modest during the World War I episode, as can be seen in Appendix Figure D.8. This contrast is plausibly linked to procurement incentives, as the low, fixed-price reimbursements of the Civil War period created strong incentives for innovation to reduce costs. While we do not know the precise details of World War I procurement arrangements for artificial limbs, cost-plus contracts, which blunt incentives for innovation to reduce costs, were “the most common type of contract” during

that period (Graske, 1941, p. 17).²²

A comparison between patents for artificial arms and legs provides an additional, suggestive piece of evidence that the emphasis of Civil War era prosthetic device patents on production processes can be linked to the Union's procurement policy. The government's procurement arrangement, namely fixed-price reimbursement of \$50 per arm and \$75 per leg (roughly \$1,000 and \$1,500 in 2018 dollars), created a strong incentive for cost-oriented production process innovation because these payments were modest relative to manufacturers' costs. Cost data from the 1860 manufacturing census indicates that payments for artificial arms implied a lower charge-to-cost ratio than for artificial legs (roughly $2/3$ vs. $3/4$), creating an even greater incentive for cost-reducing innovation. As shown in Figure D.5, patents for artificial arms did indeed exhibit a more dramatic increase in their emphasis on production process improvements, and in particular on cost reduction, in comparison with patents for artificial legs.

An alternative possibility is that the emphasis of Civil War era artificial limb patents on the production process might simply have reflected the industry's natural trajectory. That is, if artificial limbs were a "new" technology during the pre-war period, a surge in production-process innovation might naturally be expected. This is not plausible, however, as the pre-war state-of-the-art technology had existed for quite some time. Patents held by Benjamin Franklin Palmer, the pre-war artificial limb industry's leading manufacturer, extended back to 1846. Throughout the 1850s, the rate of production process innovation evolved quite smoothly for artificial limb patents as well as for patents in our control groups. The early-1860s spike in production process innovation for artificial limbs is a distinctive break from this pattern.

We next consider dimensions of quality, for which two findings are both empirically

²²Withrow Jr (1942) links the predominance of cost-plus contracts during the World War I-era to the reluctance of firms to submit bids on a fixed-price basis given the risks associated with rapidly rising prices for raw materials.

robust and connect directly to historical narratives. First, both our simple time series and synthetic control estimators provide evidence that World War I-era patents exhibit an increase in emphasis on occupation-oriented appliances (see Table 5 and Figure 3). This finding has a strong connection to the historical records regarding both the intentions of World War I-era artificial limb procurement and the specific technologies to which this period's patents gave rise. Regarding the specific technologies, these "appliances" involved interchangeable, occupation-oriented attachments like the hammer, welding, and woodwork oriented attachments shown in Figures A.4, A.5, and A.6 in appendix A. Notably, as shown in column 5 of Table 5, British World War I-era patents offer a strong piece of supplemental evidence that the demand associated with employment-oriented rehabilitation programs generated increases in emphasis on occupation-oriented appliances. This is relevant in part because the shift towards occupation-oriented appliances in the U.S. patents is, despite representing a substantial increase in percent terms, not an outlier within the relevant placebo distribution and is thus on the margins of statistical significance.

Second, both our simple time series and synthetic control estimators yield strong evidence that Civil War-era prosthetic device patents exhibit a substantial increase in emphasis on comfort (see Table 5 and Figure 3). By contrast, World War I-era prosthetic device patents de-emphasized comfort (see Table 5 and Figure 3). These findings are plausibly linked to shifts in demand, which came directly from veterans during the Civil War and from the veterans' medical bureaucracy during World War I. Of course, such a difference in innovation across wars may reflect a variety of factors aside from those that we identify. The historical record, however, as discussed in section 1, suggests that the World War I-era medical bureaucracy played a heavy hand. Our findings for this period are very much in line with the bureaucracy's de-emphasis on the veteran's comfort and emphasis on social and labor market reintegration. As with our evidence

on occupation-oriented appliances, British patents offer supplemental evidence on the decrease in emphasis on comfort during the World War I period.

5.4 Robustness of Analysis of Patent Traits

In section 4, we discussed the challenges underlying the construction of control groups in our analysis of the product and production process traits emphasized in patent documents. These challenges motivated our presentation of both a simple time series estimator and a synthetic control estimator in Table 5. In this section, we present an additional robustness analysis in which we deploy a range of alternative procedures for constructing control groups. Tables D.5, D.6, D.7, and D.8 present difference-in-differences estimates using the following approaches: Table D.5 relies exclusively on our full sample of 1,200 manually coded patents; Table D.6 uses the full sample of patents as coded using our machine learning model; Table D.7 restricts the control group to medical patent classes; finally, Table D.8 selects control groups using a simple “caliper” matching procedure.²³

The results we have emphasized throughout are findings that are robust to deploying this full set of strategies for constructing control groups, as well as to relying exclusively on the time series change in the emphases of prosthetic device patents as in equation (3). These include our findings on the Civil War-era increase in emphasis on production process innovation, the Civil War-era increase in emphasis on comfort, the World War I-era decrease in emphasis on comfort, and the World War I-era increase in emphasis on occupation-oriented appliances. In each of these cases, our estimates are robust

²³In yet another robustness check, we have constructed synthetic controls from a sample of medical and mechanical technology classes that excludes all classes that might be directly affected by wars. In addition to classes involving firearms and ammunition, we exclude surgery, classes with plausible linkages to military uniforms (e.g., boot and shoe making, buckles, etc.) camp equipment (e.g., tents), and several others. Excluding these technology classes from the set of potential “donors” to our synthetic control groups has very little effect on our estimates.

across the full range of strategies for constructing control groups and imply large percent changes in emphasis on the trait in percent terms.

In contrast with the robust evidence on the findings discussed above, our evidence on appearance and durability illustrate methodological challenges in the analysis of patent texts. The estimates in Tables 5, D.5, D.6, D.7, and D.8 reveal that our estimates for appearance and durability, and to a lesser extent materials, are sensitive to whether we look to the simple time series change, use the full set of candidate controls, or use a data-driven control group. As we discuss in greater detail in appendices A and B, these traits pose challenges with respect to both the construction of control groups and the implementation of text analysis methods. Consequently, we interpret our evidence on appearance, durability, and materials as weak. Our conclusions thus emphasize the traits for which our evidence is robust and for which we have greatest confidence in the output from our text analysis methods.

6 Discussion and Conclusion

Our analysis of Civil War and World War I-era prosthetic device patenting yields several findings of potential interest. First, we find that wartime procurement programs were associated with large increases in the volume of prosthetic device patents. We thus add to an existing body of evidence that finds that innovation can respond quite strongly to changes in demand.

Second, we find that cost-conscious production process innovation increased substantially during the Civil War. This highlights the potential relevance of the Civil War period's procurement model, which involved fixed-price reimbursement at modest rates. Experts observe that modern medical innovations have tended to bring costly enhancements to quality rather than cost-conscious improvements in productivity (Chandra and

Skinner, 2012; Skinner, 2013). Our findings provide a useful counter-example to this tendency. Demand shocks coupled with cost-conscious payment models can steer innovation in a cost-conscious direction.

Third, we find that the prosthetic device patents of the Civil War and World War I episodes diverged with respect to dimensions of quality. Civil War-era prosthetic device patents exhibited an increase in emphasis on comfort. By contrast, World War I-era prosthetic device patents de-emphasized comfort and emphasized occupation-oriented “appliances.” These differences are plausibly linked to a World War I-era shift in choice away from veterans and towards medical professionals. This shift was associated, in turn, with a heightened emphasis on veteran rehabilitation and re-employment. As a caveat, we note these differences between Civil War and World War I-era prosthetic device innovations may stem from several factors that would be difficult to empirically disentangle.

A caveat accompanying our analysis relates to the limitations of text analysis. As discussed in appendix B, seemingly modest reductions in the accuracy of our text analysis models can substantially attenuate our estimates of the effects of wartime procurement on the direction of prosthetic device innovation. While the accuracy of our models is generally quite high, it varies across the variables we construct. Moderately lower accuracy warrants caution, for example, in interpreting our analysis of the traits we term “materials” and “durability.” Further, we highlight a key difference between dimensions of product quality and aspects of the production process. Dimensions of product quality can be highly context-specific, which makes it difficult to select control groups. Consequently, we have more confidence in our analyses of attributes that relate to the production process than in our analyses of attributes that capture dimensions of quality. For researchers who desire to apply similar text analysis tools in other settings, we provide a set of best-practice insights to help guide the development and evaluation of text

analysis models.

Readers may also wonder about the rapid pace with which both the patent counts and their emphases evolved during the historical episodes we analyze. An anecdote may help to confirm that the responses we track are real. James Hanger, a renowned prosthetic limb inventor, is documented to have invented and produced a prosthetic limb within six months of being injured during the Civil War's initial skirmishes. Hanger's invention entailed improvements to both function and comfort. Hanger, Inc., the company he subsequently founded, remains in operation today. Beyond this anecdote, the tendency for large shocks to generate rapid innovative responses has been observed elsewhere. Hanlon (2015) finds, for example, that the British textile industry responded quite rapidly to the Civil War's impact on its supply chains. More recently, Agarwal and Gaule (2021) find that the COVID-19 pandemic has had a much greater and more rapid impact on innovation than long-run elasticity estimates would lead one to predict.

We conclude by reflecting on the role of innovation in enabling individuals and societies to respond to large and negative health shocks. Both wars and pandemics can have dramatic effects on the need and demand for medical innovations. Our analysis adds to a body of research on how innovation responds to these societal needs. While the overall consequences of wars and pandemics are devastating, the evidence reveals how their adverse effects can be blunted by the ingenuity of inventors and entrepreneurs.

References

- ABADIE, A. DIAMOND, A., AND J. HAINMUELLER (2010): "Synthetic control methods for comparative case studies: Estimating the effect of California's Tobacco Control Program," *Journal of the American Statistical Association*, 105(490), 493–505.
- ACEMOGLU, D. (1998): "Why do new technologies complement skills? Directed technical change and wage inequality," *The Quarterly Journal of Economics*, 113(4), 1055–1089.
- ACEMOGLU, D., AND J. LINN (2004): "Market Size in Innovation: Theory and Evidence from the Pharmaceutical Industry," *Quarterly Journal of Economics*.
- AGARWAL, R., AND P. GAULE (2021): "What Drives Innovation? Lessons from COVID-19 R&D," *IZA Working Paper 14079*.
- ANDREWS, M. (2019): "Comparing historical patent datasets," *Available at SSRN 3415318*.
- ARTS, S., B. CASSIMAN, AND J. C. GOMEZ (2018): "Text matching to measure patent similarity," *Strategic Management Journal*, 39(1), 62–84.
- ATHEY, S. (2018): "The Impact of Machine Learning on Economics," in *The Economics of Artificial Intelligence: An Agenda*, ed. by A. K. Agrawal, J. Gans, and A. Goldfarb. University of Chicago Press.
- BARNES, J. (1865): *Artificial Limbs*, Circular Order. Office of the Surgeon General.
- BARNES, J., AND E. STANTON (1866): *Artificial Limbs Furnished to Soldiers*, Ex. Doc. 108. Department of War.
- BERGEAUD, A., Y. POTIRON, AND J. RAIMBAULT (2017): "Classifying patents based on their semantic content," *PLoS ONE*, 12.
- BERGSTRA, J., AND Y. BENGIO (2012): "Random Search for Hyper-parameter Optimization," *J. Mach. Learn. Res.*, 13, 281–305.
- BERKES, E. (2018): "Comprehensive Universe of U.S. Patents (CUSP): Data and Facts," *Unpublished Working Paper*.
- BERKES, E., R. GAETANI, AND M. MESTIERI (2019): "Cities and Technology Cycles," *Unpublished Working Paper*.
- BERKES, E., AND P. NENCKA (2019): "Novel Ideas: The Effects of Carnegie Libraries on Innovation," *Unpublished Working Paper*.
- BERTRAND, M., E. DUFLO, AND S. MULLAINATHAN (2004): "How Much Should We Trust Differences-in-Differences Estimates?," *The Quarterly Journal of Economics*, 119(1).

- BLUME-KOHOUT, M. E., AND N. SOOD (2013): "Market size and innovation: Effects of Medicare Part D on pharmaceutical research and development," *Journal of Public Economics*, 97, 327–336.
- BREIMAN, L. (2001): "Random Forests," *Machine Learning*, 45(1), 5–32.
- BRODERSEN, K. H., C. S. ONG, K. E. STEPHAN, AND J. M. BUHMANN (2010): "The balanced accuracy and its posterior distribution," in *2010 20th International Conference on Pattern Recognition*, pp. 3121–3124. IEEE.
- BUDISH, E., B. N. ROIN, AND H. WILLIAMS (2015): "Do firms underinvest in long-term research? Evidence from cancer clinical trials," *American Economic Review*, 105(7), 2044–85.
- CAMERON, A. C., J. B. GELBACH, AND D. L. MILLER (2008): "Bootstrap-based improvements for inference with clustered errors," *The Review of Economics and Statistics*, 90(3), 414–427.
- CHANDRA, A., AND J. SKINNER (2012): "Technology growth and expenditure growth in health care," *Journal of Economic Literature*, 50(3), 645–80.
- CLEMENS, J. (2013): "The effect of us health insurance expansions on medical innovation," *NBER Working Paper 19761*.
- COCKBURN, I. M., R. HENDERSON, AND S. STERN (2018): "The Impact of Artificial Intelligence on Innovation: An Exploratory Analysis," in *The Economics of Artificial Intelligence: An Agenda*, ed. by A. K. Agrawal, J. Gans, and A. Goldfarb. University of Chicago Press.
- CUTLER, D. (2004): *Your Money or Your Life: Strong Medicine for America's Health Care System*. Oxford University Press, USA.
- DECHEZLEPRETRE, A., D. HEMOUS, M. OLSEN, AND C. ZANELLA (2019): "Automating Labor: Evidence from Firm-level Patent Data," *Unpublished Working Paper*.
- DEVLIN, J., M. CHANG, K. LEE, AND K. TOUTANOVA (2018): "BERT: Pre-training of Deep Bidirectional Transformers for Language Understanding," *CoRR*, abs/1810.04805.
- DOBYNS, K. W. (1994): *The patent office pony: a history of the early patent office*. Sergeant Kirklands Museum &.
- DUBOIS, P., O. DE MOUZON, F. SCOTT-MORTON, AND P. SEABRIGHT (2015): "Market size and pharmaceutical innovation," *RAND Journal of Economics*, 46(4), 844–871.
- FINKELSTEIN, A. (2004): "Static and dynamic effects of health policy: Evidence from the vaccine industry," *The Quarterly Journal of Economics*, 119(2), 527–564.

- FRIEDMAN, J. (2001): "Greedy function approximation: a gradient boosting machine," *Annals of Statistics*, 29, 1189–1232.
- GALASSO, A., AND H. LUO (2017): "Tort reform and innovation," *The journal of law and economics*, 60(3), 385–412.
- (2022): "When does product liability risk chill innovation? Evidence from medical implants," *American Economic Journal: Economic Policy*, 14(2), 366–401.
- GARCIA, D. (2013): "Sentiment during recessions," *The Journal of Finance*, 68(3), 1267–1300.
- GENTZKOW, M., J. SHAPIRO, AND M. TADDY (2019): "Measuring Group Differences in High-Dimensional Choices: Method and Application to Congressional Speech," *Econometrica*, 87(4), 1307–1340.
- GENTZKOW, M., AND J. M. SHAPIRO (2010): "What drives media slant? Evidence from US daily newspapers," *Econometrica*, 78(1), 35–71.
- GRASKE, T. W. (1941): *The Law of Government Defense Contracts*. Baker, Voorhis & Company.
- GUYATT, M. (2001): "Better legs: artificial limbs for British veterans of the First World War," *Journal of Design History*, 14(4), 307–325.
- GUYON, I., AND A. ELISSEEFF (2003): "An Introduction to Variable and Feature Selection," *J. Mach. Learn. Res.*, 3, 1157–1182.
- GUYON, I., J. WESTON, S. BARNHILL, AND V. VAPNIK (2002): "Gene Selection for Cancer Classification using Support Vector Machines," *Machine Learning*, 46(1), 389–422.
- HALL, B., A. JAFFE, AND M. TRAJTENBERG (2001): "The NBER Patent Citation Data File: Lessons, Insights and Methodological Tools," *NBER Working Paper 8498*.
- HANLON, W. W. (2015): "Necessity is the mother of invention: Input supplies and Directed Technical Change," *Econometrica*, 83(1), 67–100.
- HASEGAWA, G. R. (2012): *Mending Broken Soldiers: The Union and Confederate Programs to Supply Artificial Limbs*. SIU Press.
- HÉMOUS, D., AND M. OLSEN (2022): "The rise of the machines: Automation, horizontal innovation, and income inequality," *American Economic Journal: Macroeconomics*, 14(1), 179–223.
- HOCHREITER, S., AND J. SCHMIDHUBER (1997): "Long Short-Term Memory," *Neural Computation*, 9(8), 1735–1780.

- HOUSTON, M.H., B. J., AND L. JOYNES (1866): "Report of the Richmond Medical Journal Commission," *Richmond Medical Journal*, pp. 564–571.
- HUA, J., Z. XIONG, J. LOWEY, E. SUH, AND E. R. DOUGHERTY (2004): "Optimal number of features as a function of sample size for various classification rules," *Bioinformatics*, 21(8), 1509–1515.
- IARIA, A., C. SCHWARZ, AND F. WALDINGER (2018): "Frontier Knowledge and Scientific Production: Evidence from the Collapse of International Science*," *The Quarterly Journal of Economics*, 133(2), 927–991.
- IMBENS, G. W., AND P. R. ROSENBAUM (2005): "Robust, accurate confidence intervals with a weak instrument: quarter of birth and education," *Journal of the Royal Statistical Society: Series A (Statistics in Society)*, 168(1), 109–126.
- KHOURY, A. H., AND R. BEKKERMAN (2016): "Automatic Discovery of Prior Art: Big Data to the Rescue of the Patent System," *The John Marshall Review of Intellectual Property Law*, 16.
- KIM, Y. (2014): "Convolutional Neural Networks for Sentence Classification," CoRR, abs/1408.5882.
- KNIGHT, H. J. (2011): *Confederate Invention: The Story of the Confederate States Patent Office and its Inventors*. LSU Press.
- KOWALSKY, M. M. M. (2007): "Enabling the Great War: Ex-Servicemen, the Mixed Economy of Welfare and the Social Construction of Disability, 1899-1930," Ph.D. thesis, University of Leeds.
- LINKER, B. (2011): *War's Waste: Rehabilitation in World War I America*. University of Chicago Press.
- MAGERMAN, T., B. V. LOOY, B. BAESENS, AND K. DEBACKERE (2011): "Assessment of Latent Semantic Analysis (LSA) text mining algorithms for large scale mapping of patent and scientific publication documents," *University of Leuven Working Paper*.
- MIKOLOV, T., I. SUTSKEVER, K. CHEN, G. S. CORRADO, AND J. DEAN (2013): "Distributed Representations of Words and Phrases and their Compositionality," in *Advances in Neural Information Processing Systems 26*, ed. by C. J. C. Burges, L. Bottou, M. Welling, Z. Ghahramani, and K. Q. Weinberger, pp. 3111–3119. Curran Associates, Inc.
- MOSER, P., A. VOENA, AND F. WALDINGER (2014): "German Jewish émigrés and US invention," *American Economic Review*, 104(10), 3222–55.
- NOVOTNY, J. (2017): "To'take their place among the productive members of society': Vocational rehabilitation of WWI wounded at Erskine," *Wellcome open research*, 2.

- POPP, D. (2010): "Innovation and climate policy," *Annu. Rev. Resour. Econ.*, 2(1), 275–298.
- (2019): "Environmental Policy and Innovation: A Decade of Research," *NBER Working Paper* 25631.
- ROSENBLATT, F. (1961): "Frank Rosenblatt: Principles of Neurodynamics: Perceptrons and the Theory of Brain Mechanisms," *Spartan Books*.
- SÁIZ, P. (2000): "Base de Datos de Solicitudes de Privilegios. España 1826-1878," .
- SÁIZ, P., F. LLORENS, L. BLÁZQUEZ, AND F. CAYÓN (2008): "Base de Datos de Solicitudes de Patentes (España, 1878-1939)," .
- SCOTT DEERWESTER, SUSAN T. DUMAIS, R. H. (1990): "Indexing by Latent Semantic Analysis," *JASIS*, 41, 391–407.
- SHAPIRO, A. H., M. SUDHOF, AND D. WILSON (2018): "Measuring News Sentiment," Federal Reserve Bank of San Francisco.
- SHAPIRO, A. H., AND D. WILSON (2019): "Taking the Fed at its Word: Direct Estimation of Central Bank Objectives using Text Analytics," Federal Reserve Bank of San Francisco.
- SKINNER, J. S. (2013): "The Costly Paradox of Health-Care Technology," *MIT Tech Rev* <http://www.technologyreview.com/news/518876/the-costly-paradox-of-healthcare-technology/>. Published September, 5, 2013.
- SMITH, S., J. P. NEWHOUSE, AND M. S. FREELAND (2009): "Income, insurance, and technology: why does health spending outpace economic growth?," *Health Affairs*, 28(5), 1276–1284.
- TURNER, P., AND P. PANTEL (2010): "From Frequency to Meaning: Vector Space Models of Semantics," *Journal of Artificial Intelligence Research*, 37, 141–188.
- WATZINGER, M., AND M. SCHNITZER (2019): "Standing on the Shoulders of Science," *CEPR Discussion Paper No. DP13766*.
- WITHROW JR, J. R. (1942): "Control of War Profits in the United States and Canada," *U. Pa. L. Rev.*, 91, 194.
- YIN, W. (2008): "Market incentives and pharmaceutical innovation," *Journal of Health Economics*, 27(4), 1060–1077.

Patent Time Series Contrasting Regions Directly Impacted by the US Civil War and World War I with Regions That Were Not

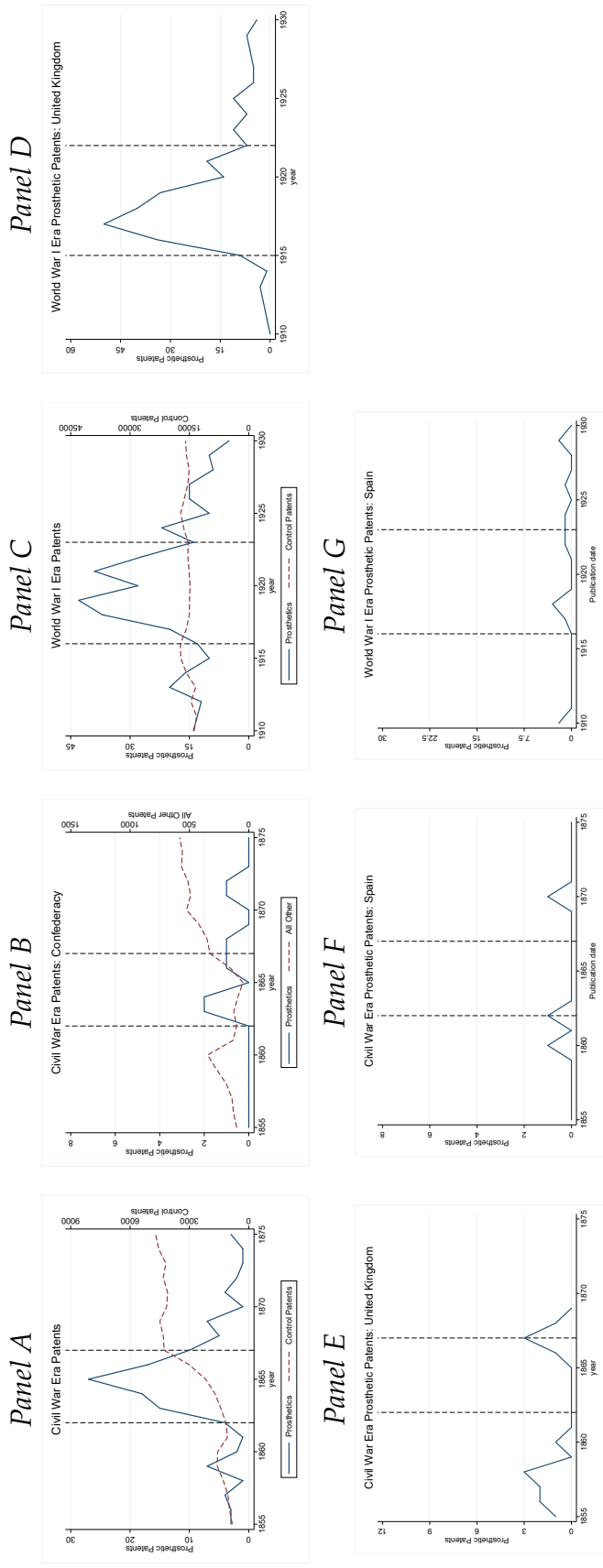

Figure 1: Patent Time Series. Note: This figure presents annual time series on patents, using USPTO data from Berkes (2018), data from the Confederate patent office as documented by Dobyans (1994) and Knight (2011), as well as data on British and Spanish patents. Dashed vertical lines indicate the periods we associate with wartime prosthetic device patenting in the United States (1862 to 1866 during the Civil War and 1916 to 1922 during World War I) or in Britain (1915 to 1922 during World War I). In USPTO data, the solid blue line corresponds with patents from USPTO class 623 "Prosthesis." The four Confederate prosthetic device patents were identified by the authors based on patent titles. British and Spanish patents were categorized as prosthetic device patents using subject matter indices. In panels using USPTO data, red dashed lines correspond with all other medical and mechanical patent classes, defined using the hierarchical structure of technological categories in the NBER Patent Database (Hall, Jaffe, and Trajtenberg, 2001).

Changes in the Averages across Production and User-Oriented Traits

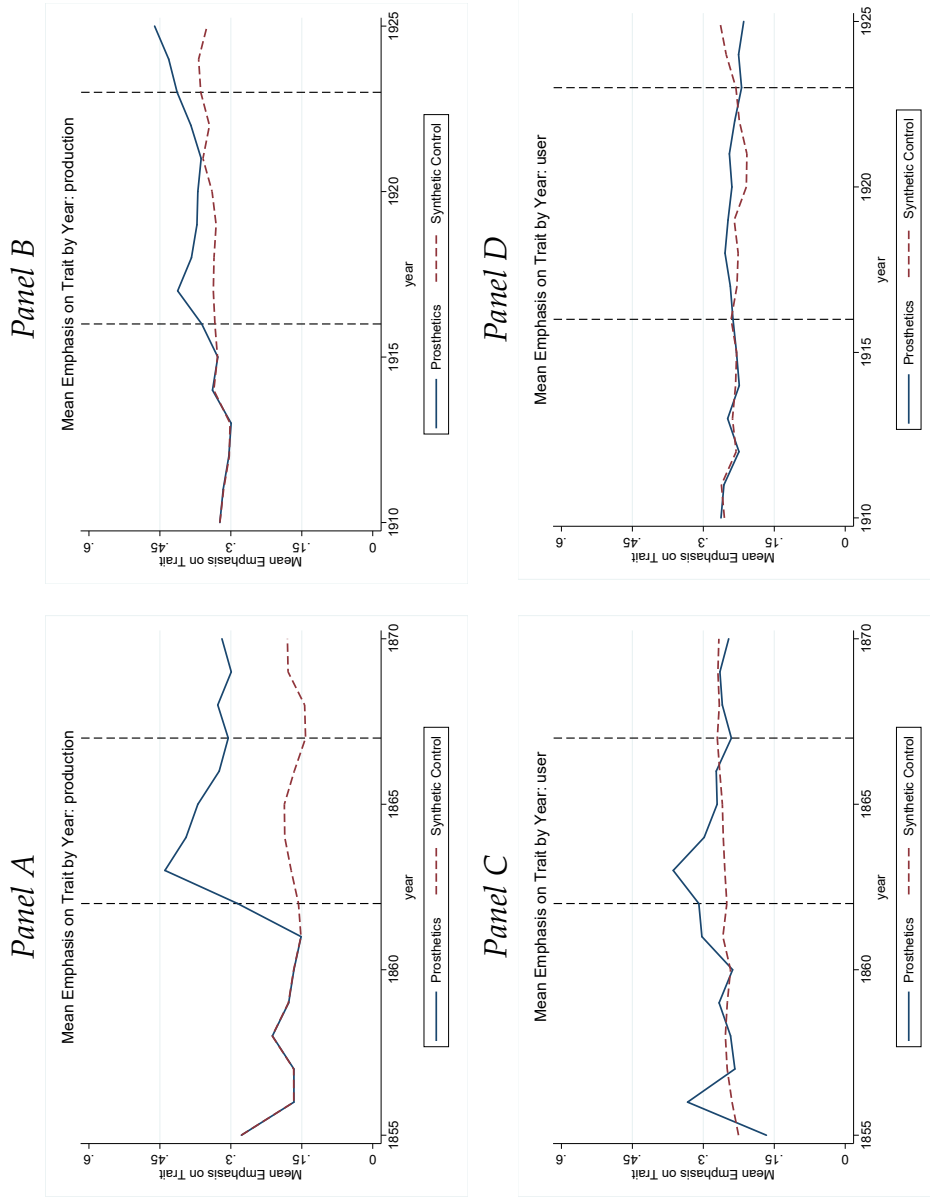

Figure 2: Changes in the Averages across Production and User-Oriented Traits. Note: The figure presents data on “treatment” and “synthetic control” series that describe the evolution of patents’ emphases on averages across trait aggregates we term “production” (a simple average across “cost,” “simplicity,” and “adjustability”) and “user” (a simple average across “appliances,” “appearance,” and “comfort”) traits. The time series in Panels B and D are calculated as 4-year moving averages. The bar charts in Panels A and C present averages of the “Prosthesis” and “Synthetic Control” series. The series plot the share of patents in a given class (“Prosthesis” or the “Synthetic Control”) that emphasize a given trait. In Panels A and C, the “Pre War” baseline extends from 1855 to 1861, and the “Wartime” period extends from 1862 to 1866. In Panels B and D, the “Pre War” baseline extends from 1910 to 1915, and the “Wartime” period extends from 1916 to 1922. We generate the synthetic control group using the “synth” package written by Abadie and Hainmueller (2010). “Donor weights” for panels A and C are chosen to match the treatment group on values extending from 1855 to 1861. “Donor weights” for panels B and D are chosen to match the treatment group on values extending from 1910 to 1915.

Changes in Traits with Strongest Connections to the Historical Record

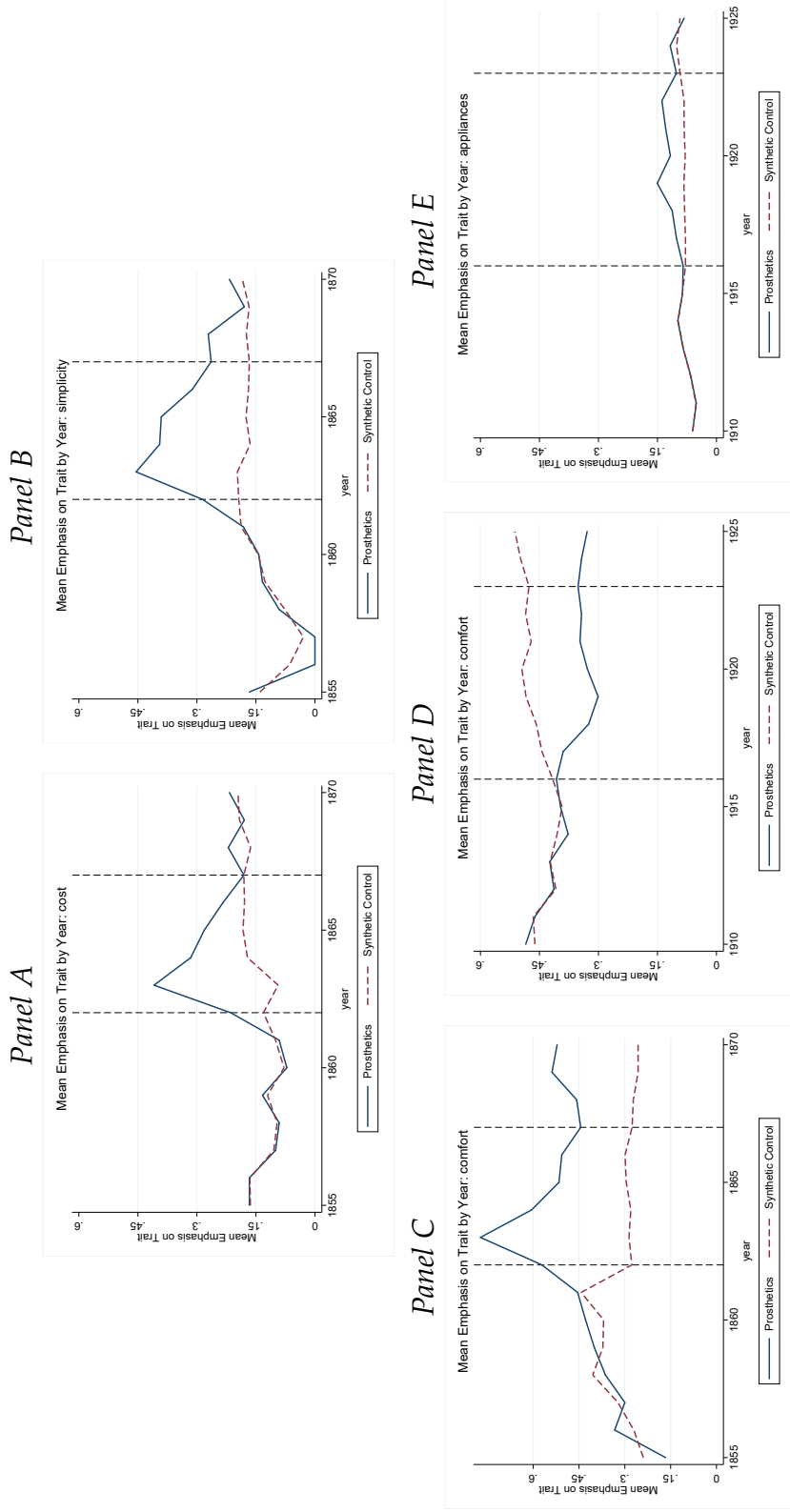

Figure 3: Changes in Traits with Strongest Connections to the Historical Record. Note: The figure presents data on “treatment” and “synthetic control” series that describe the evolution of patents’ emphases on traits we term “cost,” “simplicity,” “comfort,” and “appliances.” The time series in Panels B and D are calculated as 4-year moving averages. The bar charts in Panels A and C present averages of the “Prosthesis” and “Synthetic Control” series. The series plot the share of patents in a given class (“Prosthesis” or the “Synthetic Control”) that emphasize a given trait. In Panels A and B, the “Pre War” baseline extends from 1855 to 1861, and the “War” period extends from 1862 to 1866. In Panels C and D, the “Pre War” baseline extends from 1855 to 1861, and the “War” period extends from 1862 to 1915. We generate the synthetic control group using the “synth” package written by Abadie and Hainmueller (2010). “Donor weights” for panels A and B are chosen to match the treatment group on values extending from 1855 to 1861. “Donor weights” for panels C and D are chosen to match the treatment group on values extending from 1910 to 1915.

Table 1: Civil War Era Device Manufacturers, Patents, Early Market Shares, and Post-War Quality Rankings

Manufacturer	Patents	First Patent	Market Share	Richmond Ranking	Union Ranking
<i>Panel A: Artificial Legs</i>					
B. F. Palmer	6122, 9200, 137711	1849	30.04	2	3
Douglas Bly	23656, 24002, 25238, 31438, 38549, 38550, 57666, 87624	1859	23.01	1	1
B. W. Jewett Patent Leg Company	16360, 29494	1857	19.27	9*	> 4
E. D. Hudson	Copied Palmer's Design	na	10.92	> 4	4
William Selpho / Sepho and Sons	14836, 26378	1856	4.80	1	2
Salem Leg Company	35686, 35937, 44534, 49528, 49529, 51593	1862	4.16	9*	> 4
Charles Stafford	15831, 16420	1856	2.68	Not Considered	9*
Richard Clement	47281	1865	2.23	> 4	> 4
A. A. Marks	40763, 46687, 234596, 366494	1863	1.17	9*	> 4
American Arm and Leg Company	40956	1863	0.72	> 4	9*
National Arm and Leg Company	39599	1863	0.40	9*	9*
Marvin Lincoln	na	na	0.32	Not Considered	9*
James Hanger	Confederate Patents	1863	Large in South	9*	9*
<i>Panel B: Artificial Arms</i>					
Marvin Lincoln	39487	1863	45.51	2	2
Grenell & Co	44638	1864	13.02	1	4
H. A. Gildea	na	na	10.39	9*	4
D. W. Kolbe	45052, 255796	1864	8.58	9*	1
Selpho and Sons	18021	1857	8.53	9*	3
E. Spellerberg	42515, 51238	1864	6.49	9*	9*
National Arm and Leg Company	46158, 46159, 48002	1865	4.17	1	3
B. F. Palmer	22575, 22576	1859	2.45	9*	9*
John Condell	48659	1865	0.00	2	1

Note: The information in the table comes from a variety of sources. The criteria for a manufacturer's inclusion in the table is that he either a) accounted for at least 0.25 percent of the limbs furnished through May 1866, as documented in Barnes and Stanton (1866), or b) was highly rated by either the Union or Richmond post-war ranking. The Richmond Ranking comes from Houston and Joynes (1866). The Union Ranking comes from Barnes (1865). An entry of 9* indicates that a limb was considered and rated unfavorably or, in the case of the Union ranking, that it had been approved for reimbursement but was not included in the reported ranking. Both the Union and Richmond rankings of artificial arms had two distinct categories, resulting in multiple arms rated "1," "2," etc. An entry of > 4 indicates that a limb was considered and rated favorably, but outside of the top 4. Linkages between manufacturers and patents were generated by the authors using the Google Patent Database and manufacturer names assembled from sources including Hasegawa (2012); Barnes (1865); Houston and Joynes (1866); Barnes and Stanton (1866). Patent dates come from Berkes (2018).

Table 2: Facts on Industry Response Surrounding the Civil War

	(1859)	(1865)	(1869)
Manufacturing Establishments	5	≥ 17	24
Artificial Limb Output	≈ 350	$\geq 3,461$	$\approx 1,000-2,000$
Value of Output	\$53,000	$\geq \$223,550$	\$160,416
Patents in Surrounding 5 Years	15	87	27

Note: Data for 1865 come from Barnes and Stanton (1866) and Hasegawa (2012). Other years come from Census of Manufacturing tabulations. Patent dates come from Berkes (2018).

Table 3: Patent Attributes with Descriptions

(1) Attribute	(2) Description	(3) Narrat.	(4) Interp.	(5) Controls
<i>Individual Traits</i>				
Cost	Construction is cheap, economical, and less labor intensive	Strong	Strong	Strong
Simplicity	Device construction is simple and less complex/difficult	Strong	Strong	Strong
Adjustability	Manufactured product adaptable to user specifications	Moderate	Weak	Strong
Materials	Made from new materials, substances, and compositions	Weak	Weak	Weak
Durability	Product is able to withstand wear and damage	Weak	Weak	Moderate
Appearance	Natural appearance, life-like, tasteful, and neat	Moderate	Strong	Weak
Comfort	Device noted as comfortable, noiseless, and promoting circulation	Strong	Moderate	Weak
Appliances	Attachable artificial limb components that aid in workplace tasks	Strong	Weak	Weak
<i>Aggregate Traits</i>				
Production	Combination of simplicity, cost, and adjustability traits			
User	Combination of comfort, appearance, and appliances traits			

Note: The table describes the definitions we apply in coding each of the economic attributes on which our analysis focuses. The attributes we term cost, simplicity, and adjustability are the attributes we interpret as involving the production process, while appearance, appliances, and comfort are our user-oriented attributes. Columns 3–5 offer our assessments of the relative strengths of the historical narratives, economic interpretations, and control groups for each trait, respectively. By “strong” historical narratives, we mean that there is ample historical evidence that contemporaneous economic factors drove an emphasis on the given trait during one or both wars. By “strong” economic interpretation, we mean that a trait can be cleanly linked to aspects of labor productivity, buyer desires, or mass production. By “strong” control groups, we assess that the keywords describing the given trait have similar meanings and rates of use in control classes as in the prosthetic limb class.

Table 4: Relative Increases in Prosthetic Device Patenting During the Civil War and World War I

	(1)	(2)	(3)	(4)	(5)	(6)	(7)
	All Cntrls	Matched	Medical	Misc. Mech.	Metal	Mater. Proc.	Non War
<i>Panel A: Full Sample</i>							
Prosthetics x War	0.951 (0.267)	0.853 (0.298)	0.981 (0.294)	0.883 (0.194)	1.015 (0.269)	1.021 (0.338)	0.945 (0.255)
N	432	88	34	128	56	92	362
Clusters	216	44	17	64	28	46	181
Estimator	OLS	OLS	OLS	OLS	OLS	OLS	OLS
Class-by-Episode FE	Yes	Yes	Yes	Yes	Yes	Yes	Yes
Period Effects	Yes	Yes	Yes	Yes	Yes	Yes	Yes
SEs in Parentheses	Clustered	Clustered	Clustered	Clustered	Clustered	Clustered	Clustered
Randomization Inf.	P < .01	P < .01	P < .01	P < .01	P < .01	P < .01	P < .01
<i>Panel B: Civil War</i>							
Prosthetics x War	1.216	0.793	1.259	1.071	1.260	1.348	1.198
Randomization Inf.	P < .01	P < .01	P < .01	P < .01	P < .01	P < .01	P < .01
N	188	88	14	56	24	42	156
<i>Panel C: WWI</i>							
Prosthetics x War	0.687	0.571	0.716	0.697	0.774	0.698	0.693
Randomization Inf.	P < .05	P < .2	P < .01	P < .03	P < .01	P < .01	P < .04
N	244	32	20	74	34	52	208

Note: The table presents estimates of equation (1). The control group used for each regression is described in the column heading. The sample for Panel A includes both the Civil War and World War I episodes, while the sample for Panel B consists solely of the Civil War episode and the sample for Panel C consists solely of the World War I episode. For observations associated with the Civil War, the pre-war period extends from 1855 to 1861, while the period over which the war influenced prosthetic device patenting is defined to extend from 1862 to 1866. For observations associated with World War I, the pre-war period extends from 1910 to 1915, while the period over which the war influenced prosthetic device patenting is defined to extend from 1916 to 1922. In Panel A, the standard errors reported in parentheses allow for clusters at the patent class-by-war episode level. In each panel, the p-values reported in rows labeled "Randomization Inf" are based on the position of the point estimate in the distribution of placebo point estimates that are constructed using a procedure along the lines recommended by Imbens and Rosenbaum (2005). Additional details are reported in the main text.

Table 5: Changes in the Nature of Prosthetic Device Patents

	(1) US Civil War Simple Diffs	(2) Synth Estimate	(3) US WWI Simple Diffs	(4) Synth Estimate	(5) GB WWI Simple Diffs	(6) Notes
<i>Panel A: Aggregated Traits</i>						
Production Average	0.187 (0.000) [0.000]	0.190 (0.000) [0.000]	0.074 (0.008) [0.016]	0.038 (0.049) [0.098]	0.124	Strong Civil War Narrative (+)
User Average	0.006 (0.330) [0.660]	0.036 (0.054) [0.108]	-0.007 (0.139) [0.279]	0.019 (0.115) [0.230]	-0.109	
<i>Panel B: Individual Traits</i>						
Cost	0.152 (0.032) [0.064]	0.141 (0.054) [0.109]	0.079 (0.074) [0.148]	0.050 (0.066) [0.131]	0.028	Strong Civil War Narrative (+)
Simplicity	0.238 (0.032) [0.064]	0.195 (0.011) [0.022]	0.043 (0.254) [0.508]	-0.001 (0.557) [0.990]	0.226	Strong Civil War Narrative (+)
Adjustability	0.171 (0.000) [0.000]	0.076 (0.143) [0.286]	0.099 (0.016) [0.033]	0.116 (0.008) [0.017]	0.118	
Appliances	0.049 (0.106) [0.213]	NA	0.065 (0.049) [0.098]	0.038 (0.066) [0.131]	0.112	Strong WWI Narrative (+)
Comfort	0.150 (0.032) [0.064]	0.303 (0.016) [0.033]	-0.119 (0.000) [0.000]	-0.116 (0.000) [0.000]	-0.230	Strong WWI (-) and Civil War (+) Narratives
Appearance	-0.182 (0.043) [0.085]	0.078 (0.037) [0.074]	0.033 (0.107) [0.213]	0.068 (0.008) [0.016]	-0.209	
Durability	0.016 (0.372) [0.745]	0.149 (0.083) [0.167]	0.064 (0.041) [0.082]	0.025 (0.172) [0.344]	0.102	
Materials	0.026 (0.138) [0.277]	0.035 (0.104) [0.209]	0.008 (0.328) [0.656]	-0.005 (0.496) [0.990]	-0.050	

Note: The table presents estimates of the effect of wartime procurement arrangements on the fraction of prosthetic device patents that emphasize a given economic trait. Estimates in columns labeled “Simple Diffs” are of β^{TS} from equation (3), while estimates in columns labeled “Synth Estimate” are estimates of β^{DD} from equation (4), where the control group is constructed separately for each trait using the synthetic control procedure described in greater detail in the main text. One-sided p-values are presented in parentheses beneath each point estimate, and two-sided p-values are presented in brackets. In several instances (including Civil War era production process innovation, WWI era de-emphasis on comfort, and WWI era emphasis on employment-enhancing “appliances”), the historical narrative delivers strong one-sided predictions for the evolution of prosthetic device patents. All p-values are generated using randomization inference (Imbens and Rosenbaum, 2005), which in this application involves straightforwardly ranking the point estimate for the prosthetic device technology class against the “placebo” point estimates associated with the other technology classes in our sample.

Appendix Material: For Online Publication

A Patent Trait Appendix: Examples, Illustrations, and Historical Narratives

This appendix provides descriptions and examples of patents that emphasize the traits used in our analysis. These traits include “cost,” “simplicity,” “adjustability,” “appliances,” “materials,” “durability,” “appearance,” and “comfort.” We connect these traits to specific instances of concrete technological change. We also detail the relative ease or difficulty of identifying each traits using a set of keywords.

A.1 Cost

Technological advancements related to our “cost” trait led to a cheaper production process. One artificial limb patent emphasizing costs, for example, claims an advancement that improves the modularity of the device, allowing for uniform construction, by letting the manufacturer “replace or modify any one portion of [the limb] without altering the other portions and at very small expense” (U.S. 35,686; 1862). Another patent describes a new limb that facilitates cheaper, uniform construction by using parts that are adjustable to different users. It reads, “adjustment of the parts of an artificial limb...to adapt it to the length of the natural limb and conformation of the foot of the intending wearer, by which means the necessity of making a limb to suit each particular case is to a great extent obviated, and in consequence, the cost of manufacture is considerably reduced” (U.S. 37,282; 1863). These patents describe a more modular, uniform artificial limb design that leads to a cheaper production process.

Straightforward cost-oriented innovations are also present in other technological categories that form our control groups. A patent for a Civil War-era carriage cover, for

example, emphasizes a “cheap, light and convenient covering from storms or the heat of the sun” (U.S. 32,477; 1861). Examples such as this, from technology classes other than prosthetic devices, lead us to designate “cost” as a trait for which control groups can reasonably be identified.

See Figure A.1 for keywords we used to identify “cost” innovations, including words like “cheap” and “economical.” We identify “cost” as a trait for which text analysis methods can be implemented effectively.

A.2 Adjustability

New technologies that allow a product to be adjusted to user specifications are labeled as having the “adjustability” trait. Adjustable products enhance mass producibility by bypassing the need to tailor-make a product to accommodate the needs of a specific individual.

An example of an artificial limb patent that describes this type of advancement reads, “The improved artificial leg ... is so constructed that its length may be easily and nicely adjusted to suit the wearer” (U.S. 35,937; 1862). As mentioned above, U.S. patent 37,282 (1863) also advances mass producibility through the use of adjustable parts to adapt the limb “to the length of the natural limb...of the intending wearer...by which means the necessity of making a limb to suit each particular case is to a great extent obviated” (U.S. 37,282; 1863). These examples highlight advancements in artificial limbs that allow for uniform construction by enabling limbs to fit the user through adjustable parts.

Adjustability is broadly applicable to many types of technologies. For example, this trait is relevant when describing advancements in machinery that eliminate the need for additional parts to adapt to user specifications. These advancements simplify the production process by shedding extraneous components. One such patent describes a machine that can be “made adjustable in inclination” to suit the needs of multiple

users (US 10,687; 1854). Although this trait is straightforward for wearable products, it is slightly more difficult to identify in machinery technologies using simple keyword searches. This leads us to identify “adjustability” as a trait for which control groups can reasonably be constructed using other technological classes. However, it is not quite as straightforward as the “cost” trait.

See Figure A.1 for keywords we used to identify “adjustability” innovations, including words like “adjust” and “adjustability.” We note, however, that the concept of “adjustability” that we have in mind is more cleanly identified through close readings than through keywords. The keywords alone, for example, sometimes captured patents simply referring to the process of “adjusting” a screw to build the product. This instruction is obviously not an advancement in mass production. Thus, close readings can better identify patents for which the emphasis is on the product’s mass producibility. This leads us to identify “adjustability” as a trait for which we rate the trait’s ease of interpretability as weak, despite the clarity of its economic content.

A.3 Simplicity

The trait “simplicity,” as used in 19th-century artificial limb and mechanical patents, describes advancements that simplify the design and fabrication of new technologies. For example, one artificial limb patent states the use of a knee joint that mimics the natural simplicity of the human knee joint, avoiding unnecessary parts and ensuring “great simplicity, and therefore cheapness” (U.S. 37,087; 1862). Figure A.12 shows a diagram of the knee joint with comparisons to the simplicity of the natural human knee joint. This patent emphasizes an advancement that leads to simple construction and lower production costs.

Like the previous two traits, the language that connects “simplicity” to a streamlined production process is not unique to artificial limbs. For example, a mechanical patent

from the same era describes an advancement in a water pump as being “simple and cheap” (U.S. 15,221; 1856). Together, these examples illustrate the consistency of the language linked to “simplicity” across technology classes and highlight a trait whose meaning is easily derived in text analysis. This leads us to identify “simplicity” as a trait for which the control groups can reasonably be constructed using other technological classes.

Figure A.1 provides the list of keywords we used to identify technological advancements in “simplicity.” The keywords used include “simple,” “difficult,” and “complex.” The straightforward meanings of the relevant keywords help illustrate why we identify “simplicity” as a trait for which text analysis methods can be implemented effectively.

A.4 Appliances

Patents emphasizing improvements in tool attachments for artificial limbs are deemed as having the “appliances” trait. Such tools allow artificial limb wearers to operate machinery and perform a trade or skill, facilitating integration into the post-war workforce. “Appliances” is an example of a trait that is highly specific to artificial limbs as an applied technology. We thus identify “appliances” as a trait for which it is not particularly useful to construct control groups using other technological classes.

Despite being highly-specific, the associated economic content of our “appliances” trait is clearly defined. An example of an “appliances” innovation from a U.S. inventor during the World War I era states, “other appliances may be readily fastened in the arm end and tightly gripped there-by” (U.S. 1,213,222; 1917). A similar emphasis on attachable tools was seen in British patents during WWI. One such patent emphasizes that, “the invention has for its object to provide a mechanically worked elbow joint to which may be fitted a lower forearm member with or without a hand or an extension piece for appliances and other fitments” (GB113329A; 1917). Figures A.3, A.4, A.5, and

A.6 show examples of these new appliance technologies, including a hand for writing, for soldering, and for hammering.

See Figure A.1 for keywords we used to identify “appliances” innovations, including words like “appliances” and “fittings.” This terminology highlights that “appliances” is a trait for which domain-specific knowledge is essential for connecting text to the relevant economic concept. Once that domain-specific knowledge has been obtained, however, the nature of the technological advance is very clear, as illustrated in Figures A.3, A.4, A.5, and A.6.

A.5 Materials

Technological advancements in “materials” signify new materials, substances, compounds, or compositions used in the production process. Such advancements may lead to more efficient production processes and increased functionality.

An artificial limb patent describes one such advancement stating, “The socket...is composed of hard or vulcanized India-rubber...the rubber socket is simply tightened down upon the stump by means of the leather straps, and a perfect fit is secured at all times” (U.S. 38,550; 1863). The new use of vulcanized rubber improved the fit of artificial limbs. Another patent emphasizes a material advancement that leads to a more efficient production process, saying, “the foot and hand...[are] a composition of ‘sponge rubber’...by this means I avoid the use of springs, pivots, joints... and also avoid the great expense and wear, making the limbs cheaper and more durable” (US 40,763; 1863). This trait can be complicated to encode as certain materials may only be relevant for a given technological class and may only be “innovative” for a limited time.

See Figure A.1 for keywords we used to identify “materials” innovations, including words like “vulcanized” and “duralumin,” both of which were new materials in the 19th and 20th centuries, respectively. These keywords help to illustrate that highly spe-

cialized knowledge may thus be necessary to capture materials innovations using text. Additionally, the materials associated with innovative designs will vary across technological classes, which complicates the construction of control groups. We thus identify “materials” as a trait for which it is not particularly useful to construct control groups using other technological classes.

A.6 Durability

Improvements in “durability” signify inventions that aim to prevent the deterioration of an artificial limb over time. These improvements often utilized new materials or methods to create artificial limbs that lasted longer and required less-frequent replacement or repair.

An artificial limb inventor during the Civil War describes the new design of an artificial leg by which “a strong and durable leg can be made” (U.S. 46,687; 1865). To achieve this level of durability, the inventor utilizes an innovative pear-shaped button to secure the movement of the artificial leg even when bent. Durability is fairly encodable in control classes as well. In one example, an inventor emphasizes a sounder construction of a wood boring machine for which the cogwheels within the frame “are arranged in a convenient and durable manner” (U.S. 3,645; 1844).

See Figure A.1 for keywords we used to identify “durability” innovations, including words like “rot” and “burst.” As with our materials trait, these keywords help to illustrate that specialized knowledge may be necessary to capture durability innovations using text. These keywords are mostly related to durability innovations for technologies made of wood, a central material of Civil War limb manufacturing. Additionally, the durability associated with innovative designs may vary across technological classes, which includes aspects of unique materials used during construction to improve durability. These insights complicate the construction of control groups. We thus identify

“durability” as a trait for which it is difficult to encode in prosthetic limbs and control technological classes.

A.7 Appearance

Artificial limb patents emphasizing a natural, life-like, tasteful, and neat appearance are labeled as having our “appearance” trait. These limbs are more discrete and make the artificial limb less obvious.

One such patent emphasizing “appearance” illustrates that “[this construction]...gives the limb a more natural appearance” (US55,645; 1866). Another patent describes the construction of an artificial hand and emphasizes its “most natural appearance” due to a “substantially smooth and continuous surface” (US 1,173,219; 1915). The top panel of Figure A.7 illustrates this new technology with a more natural appearance relative to the predominant “Carne’s hand” in the lower panel (US 999,484; 1910). Notice the continuous and smooth surface of the natural hand, especially at the joints, when compared to the more mechanical and rigid joints of The Carne’s Hand.

Appearance is also relevant for certain user-oriented mechanical innovations. For example, an advancement in cotton gins aims “to produce the finest sample or make the best and most presentable appearance” (U.S. 418,084; 1889). In this case, the quality of the output (cotton) depends on its presentability. For some mechanical innovations, however, appearance is not as relevant. This is an example of a trait for which control technologies must be selected carefully to ensure the trait’s relevance, and where estimation using a simple time series changes may be preferable to using other classes of technologies to construct a control group.

See Figure A.1 for keywords we used to identify “appearance” innovations, including words like “neat” and “tasteful.” We identify “appearance” as a trait for which ease of interpretability is relatively strong.

A.8 Comfort

Many 19th-century artificial limbs were quite uncomfortable, noisy, and smelly. Advancements to improve circulation and make limbs more comfortable are labeled as having the “comfort” trait.

An example of a patent that claims an artificial limb that is more comfortable is given in U.S. patent 53,206 (1866). The inventor emphasizes a novel way of constructing the inner lining of artificial limbs using cork sheets instead of traditional hard leather or rubber materials. He describes the invention as having a “smooth, soft surface, that is not materially affected [by] perspiration, because the pores in the cork allow said perspiration to escape, and said cork affords a pleasant, smooth surface to the tender stump.” Figure A.16 illustrates the construction of this cork lining. Some mechanical patents also emphasize comfort by, for example, suggesting that the sitting apparatus in the machine is made more comfortable for the user (U.S. 44,198; 1864).

Although some mechanical patents emphasize comfort, this trait stands in contrast with “simplicity” as a relatively complex trait. Difficulties arose as the language used to indicate a product’s “comfort” was often ambiguous. For example, the word “disturbing” often connotes bodily discomfort in prosthetic device patents. In mechanical classes, by contrast, the word “disturbing” tends to have meanings connected to the device’s functionality (e.g., “disconnecting or disturbing the pump”). Thus, machine learning algorithms helped improve the accuracy of our “comfort” labels in the control group by overcoming these ambiguities. However, “comfort” is another example of a trait for which care should be taken when selecting control technologies, and where estimation using a simple time series methods may be preferable.

See Figure A.1 for keywords we used to identify “comfort” innovations, including words like “circulation” and “pain.” We identify “comfort” as a trait for which the ease of interpretability is moderate. Despite the clarity of the economic content itself,

the semantic complexity of the trait is non-trivial, in part because of variations in how comfort might be described across technology classes.

A.9 How Traits Relate to Technologies Influenced by Procurement

In this section, we detail how the traits we analyze capture technological changes as influenced by the desires of wartime procurers. First, we describe a set of traits related to the reintegration of veterans with amputated limbs into the workforce. We supplement this discussion with historical evidence on the demands of World War I era procurers. Then, we highlight traits related to advancements in mass production driven by the need to provide an unprecedented demand for artificial limbs associated with both the Civil War and World War I. Lastly, we detail how competitive pressures from consumer-directed limb purchases steered inventors to entice veterans with more desirable limbs.

A.9.1 Technologies for Employment and Social Reintegration (Appliances, Appearance)

Before World War I, the cost of the U.S. Civil War pension system outpaced the cost of the Civil War itself. In response, the U.S. government implemented a rehabilitation system focused on reintegrating veterans with amputated limbs into the workplace. These veterans “were expected to become citizen-workers...not to languish at the expense of the U.S. Treasury. In a real sense, they were expected to be the opposite of the Civil War veteran” Linker (2011, p. 13). The British, too, learned from the American Civil War experience and focused on providing limbs geared to improve the employment prospects of veterans with amputated limbs. To accomplish this, both governments launched new initiatives to train veterans with amputated limbs to use artificial limbs in a new skill or trade before returning home. They contracted with limb manufacturers to compete against one another to invent artificial limb attachments for these trades (Kowalsky,

2007).

Together, these forces led inventors to focus on technologies that improved the utility of artificial limbs (see Figure 3 and Table 5), with the increase being particularly strong in Britain. We measure changes in these technologies using the trait “appliances.” Figures A.3, A.4, A.5, and A.6 show improvements in the utility of artificial limbs during World War I. Figure A.3 illustrates a case of a soldier fitted with artificial arms that facilitate writing. Figure A.4, taken from Linker (2011), shows a veteran with an amputated arm using a “utility arm” with a welding attachment. Figure A.5 shows a diagram from U.S. patent 1,213,222 (1917), which illustrates a new artificial arm with an attachable hammer. Figure A.6 displays a photo taken at Roehampton (a British army-training facility during World War I) that shows soldiers using various interchangeable terminal devices designed for specific trades. These artificial limb innovations facilitated reintegration into employment upon returning home.

The emphasis on the utility of limbs was coupled with a focus on improving limb appearance (see the bottom-right panel of Figure A.2). Institutions strove to disguise the disability of veterans with amputated limbs. A War Risk Insurance Bureau chief noted that “one of the most useful and necessary duties of this department will be to prescribe and furnish medical and surgical treatment in order that disabilities may be reduced or caused to disappear entirely” (Linker, 2011, p. 100).

Inventors responded to these desires by creating more life-like artificial limbs. These technologies are captured by our “appearance” trait. Figure A.7 illustrates a new technology displayed in U.S. patent 1,173,219 (1915), which emphasizes a more natural-looking hand through the use of continuous and smooth surfaces.

A.9.2 Mass Production During War

The Civil War brought an unprecedented demand shock to the U.S. artificial limb industry. The surge in demand led manufacturers to increase the mass producibility of their limbs. Manufacturers brought new materials advancements that made artificial limbs cheaper, simpler, and adjustable to user specifications (see Figure D.7). For example, Amasa Marks, a prominent limb manufacturer whose firm persisted into World War I, filed U.S. patent 40,763 (1863), which details the construction of limb appendages using one such new material. The patent reads, “making the wearing parts of the limbs...of a composition of ‘Sponge rubber’... [giving] the requisite degree of elasticity...making the limbs cheaper and more durable.” Marks’ use of vulcanized rubber allowed his limbs to be mass-producible through cheaper components that adjust to different stump sizes (elastic). Figure A.8 shows a diagram from the patent illustrating the new materials technology.

Inventors also emphasized adjustability as a way to mass-produce limbs to meet pressing demand. U.S. patent 66,728 (1867) emphasizes an adjustable lacer for artificial limbs allowing a close fit to knee joints of different sizes. Figure A.10 shows a diagram of this invention. U.S. patent 35,937 (1862) highlights the use of a spindle in the knee joint that allows the limb to adjust to the height of any wearer. Figure A.11 shows the construction of this limb, with part D showing the adjustable spindle at the knee joint.

Simpler limbs also made for a quicker and less labor-intensive production process. U.S. patent 37,087 (1862) states the use of an artificial knee joint that mimics the natural simplicity of the human knee joint, avoiding unnecessary parts and ensuring “great simplicity, and therefore cheapness.” The inventor describes a hinge joint of the artificial knee as one constructed of only “two principal parts, the upper part, representing the femur...and the lower part, representing the tibia.” In contrast to Figure A.13, which shows a more complex knee joint, Figure A.12 shows a diagram of the described knee

joint, illustrating the simplicity of the invention.

Although a strong domestic manufacturing presence was established during the Civil War, U.S. manufacturers were enlisted to meet global artificial limb needs during WWI. This led U.S. artificial limb manufacturers to invest further in standardization (Guyatt, 2001, p. 313).

Inventors during World War I used modular construction to keep up with global demand. The “E-Z limb” was a standard-issue, temporary limb for acclimating veterans with amputated limbs to the use of an artificial limb before being discharged from military service. These limbs were modular and lightweight to facilitate mass production and showcased a smooth flesh-colored exterior that resembled the “shape of a real-life human leg” (Linker, 2011, p. 109). Figure A.9 illustrates the features of “E-Z limb.” An increased emphasis on adjustability was thus common to prosthetic device patents during both World War I and the Civil War (see Table 5 and Figures D.7 and D.8). By contrast, inventors exhibited a much smaller increase in their emphasis on cost and simplicity during World War I than during the Civil War (again, see Table 5 and Figures D.7 and D.8).

A.9.3 Cost and Comfort Oriented Innovation During the Civil War

Lastly, two features of Civil War-era procurement contributed to increases in inventors’ emphasis on cost and comfort. With respect to cost, the government’s modest, fixed price reimbursement rates gave Civil War-era limb manufacturers a strong incentive to reduce production costs. Civil War-era inventors responded by increasing their emphasis on making limbs inexpensive (see Figure D.7). One such artificial limb patent detailing a cost innovation states, “[The artificial limb] is simple, cheap...” (U.S. 37,637; 1863). To achieve cheapness, the inventor sheds “the use of straps around the waist or shoulder” and obviates “tedious fitting” by using a “bucket or socket to receive the stump of

the amputated limb,” which can secure the limb to the stump. This new technology is shown in Figure A.14. Another inventor claims a new artificial arm design constructed entirely out of metal, “avoiding the use of catgut, whalebone, wood, or any other organic substance” and thus leading to “cheapness” (U.S. 40,397; 1863). Figure A.15 shows the design of this metallic artificial arm.

With respect to comfort, Civil War veterans with amputated limbs received government limb allowances to finance the purchase of an artificial limb of their choosing. In addition, limb purchase was not required. This appears, in practice, to have led at least some manufacturers to strive to produce more comfortable artificial limbs (see the top-left panel of Figure A.2). In one example, an inventor details a new way to construct the inner lining of artificial limbs by using cork sheets. This construction is described as having a “smooth, soft surface, that is not materially affected [by] perspiration, because the pores in the cork allow said perspiration to escape, and said cork affords a pleasant, smooth surface to the tender stump”(U.S 53,206; 1866). Figure A.16 illustrates the construction of this cork lining.

By contrast, during World War I, the U.S. government de-emphasized the comfort of veterans with amputated limbs in favor of a strict rehabilitation program. Indeed, this program incorporated regiments of intentionally inflicting pain out of fear that a less severe approach would hinder rehabilitation. One source notes, “By eliciting pain from disabled soldiers, then, physiotherapists complied with the greater vision of the rehabilitation project...a vision fueled by the fear that overly sympathetic women would ruin a man’s prospect of successful rehabilitation” (Linker, 2011, p. 75). Soldiers often complained that government-provided limbs were painful (Linker, 2011, p. 114). In the prosthetic device patents, we see this reflected in our analysis of the “comfort” trait, with inventors de-emphasizing comfort during World War I (see the top-right panel of Figure A.2).

Appendix Figure A.1: Trait Keyword List

Adjustability	Cost	Materials	Simplicity	Appearance	Comfort	Appliances	Durability
adjust (I/W)	cheap (I/W)	substances	simple (I/W)	conceal (I/W)	unpleas (I/W)	appliance	durability
adjusting (E)	expens (I/W)	materials	simpli (I/W)	appearance (I/W)	circulation	appliances	strength
	inexpen (I/W)	compounds	simplif (I/W)	finish	noise	fittings	durabl (I/W)
	cost (I/W)	compositions	difficult	life (I/W) (P)	noisy	tools	strength
	econom (I/W)	vulcanized	complex	unsight (I/W)	noiseless	fitments	strengthen
		duralumin	complicat (I/W)	sightly (I/W)	noiselessly		strong
		celluloid	simplicity	beautif (I/W)	perspiration		dirt
		laminated		beauty	comfort (I/W)		waterproof
		polymer		hides (I/W)	rattle		friction
		certalmid		neat	soft (P)		preserv (I/W)
		vulcanite		neatness	ventila (I/W)		break
		filaments		ugly	pain		rot
		resisting		ugliness (I/W)	painful		tougher
				neater	chafe		leakage
				handsome	chafing		leak
				tasteful	odor		corrosion
				life-like	offensive		corrosive
				resembl (I/W)	rattling		burst
				wrinkle (I/W) (P)	rattles		weak
				embarrassment	clicking		
				ornamentation	creak		
				sight (P)	creaking		

Note: The figure presents the keywords we used to define our traits of interest. The acronym “I/W” means “in word”, which denotes that we use all words that contain the given keyword. The letter “E” means we exclude any word containing that keyword. The letter “P” means that the machine learning algorithm learned to avoid using these keywords beyond the context of prosthetic limbs.

User Traits of Mechanical Patents

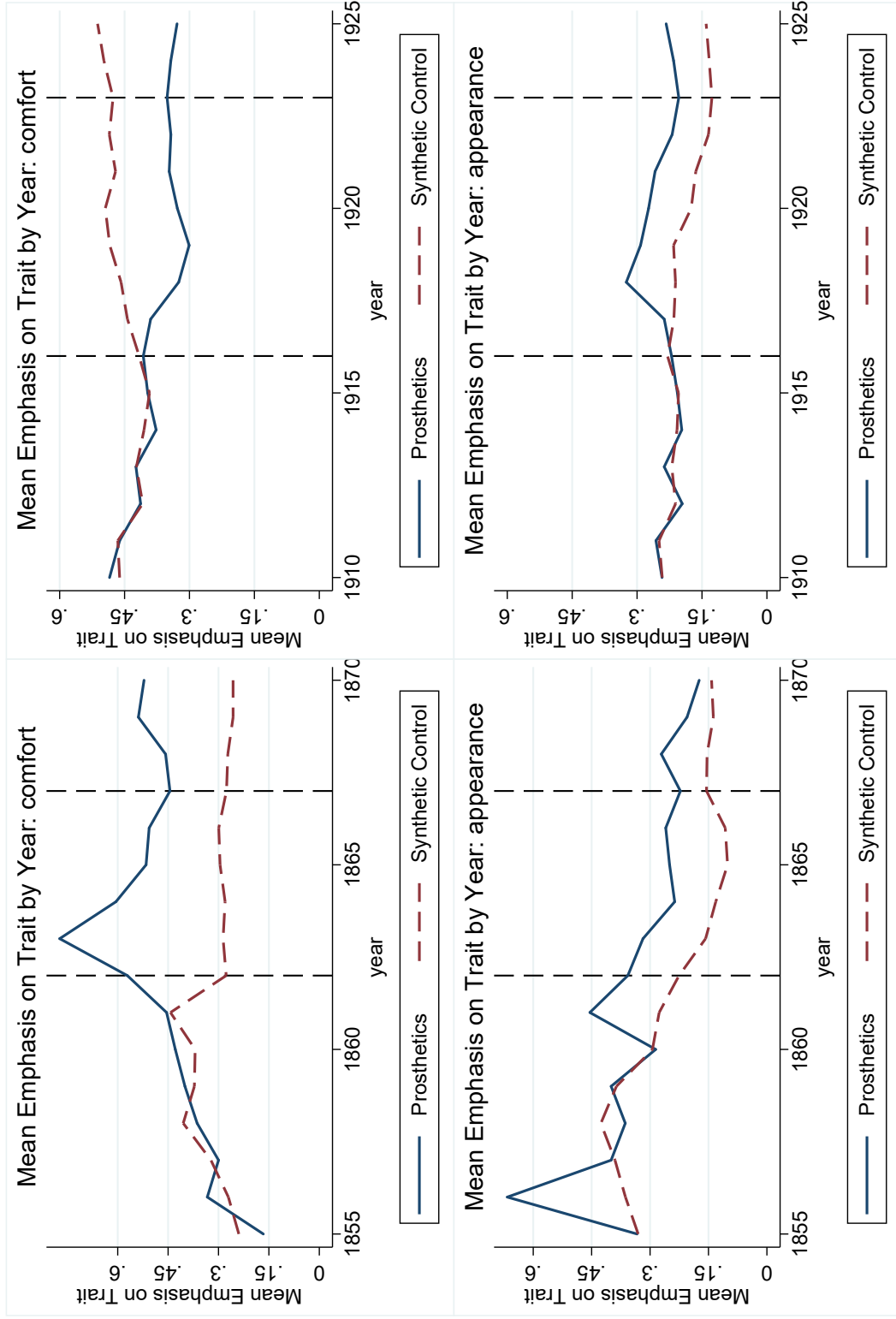

Appendix Figure A.2: Quality-Oriented Traits: Civil War and World War I Synthetic Controls

Note: The figure presents “treatment” and “synthetic control” series that describe the evolution of patents’ emphases on the traits we term “comfort” and “appearance.” Further information on the definitions of each trait can be found in table 3 as well as in the main text. All series in the figure are calculated as 4-year moving averages. The series plot the share of patents in a given class (“Prosthesis” or the “Synthetic Control”) that emphasize a given trait. We generate the synthetic control group using the “synth” package written by Abadie and Hainmueller (2010). For the panels in column 1, “Donor weights” are chosen to match the treatment group on values extending from 1855 to 1861. For the panels in column 2, “Donor weights” are chosen to match the treatment group on values extending from 1910 to 1915.

Appendix Figure A.3: Regaining Writing Ability

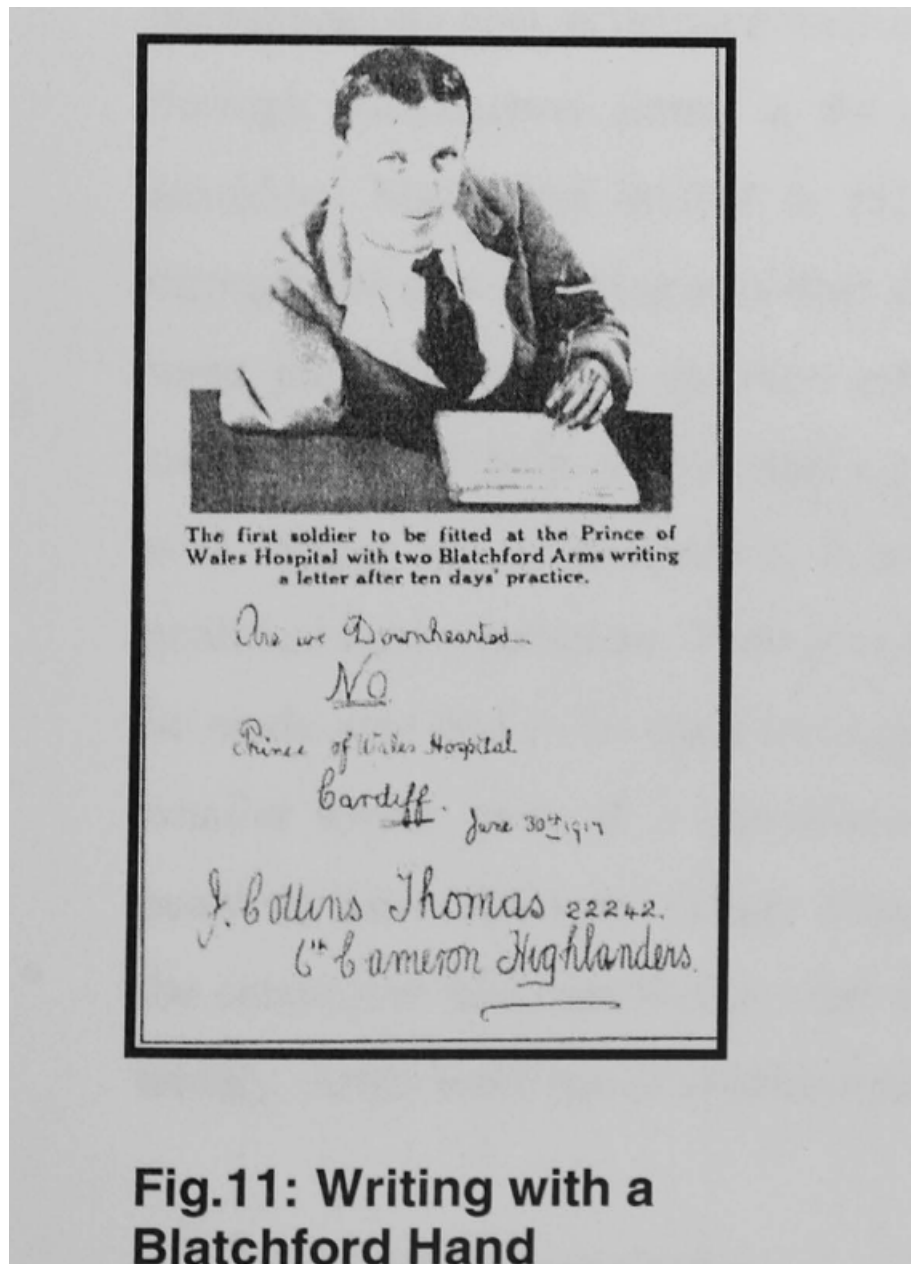

Note: The diagram was taken from the article "Enabling the Great War: Ex-Servicemen, the Mixed Economy of Welfare and the Social Construction of Disability, 1899-1930" by Meaghan Melissa Marie Kowalsky. The figure shows an example of a prosthetic arm appliance attachment for writing.

Appendix Figure A.4: Rehabilitated to Work

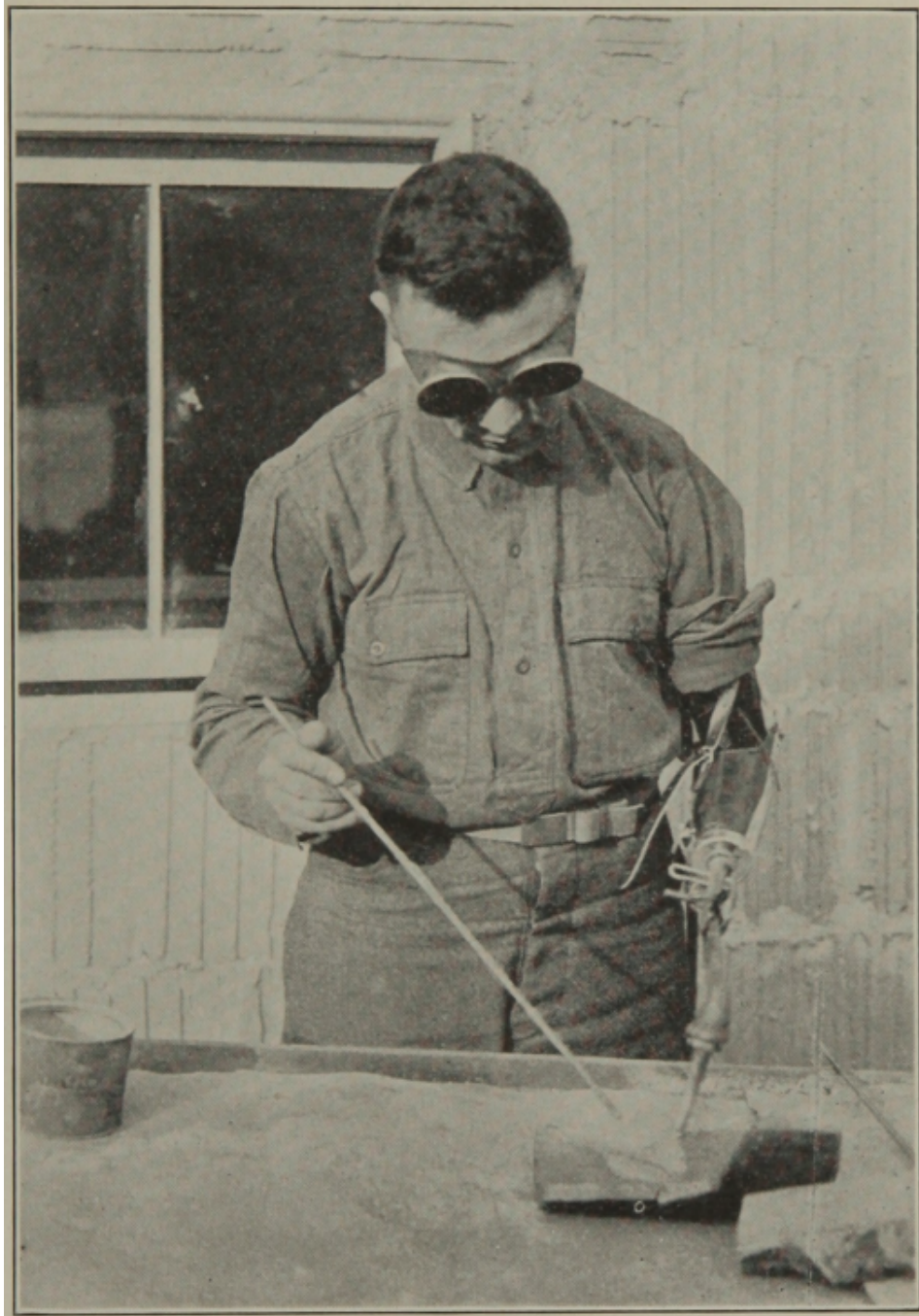

Note: The figure shows an example of a prosthetic arm appliance attachment for welding. Source: The United States Army Surgeon General's Office, *The Medical Department of the United States Army in the World War*, Washington, DC: GPO, 1927, volume 13, page 107.

Appendix Figure A.5: Rehabilitated to Work (Part II)

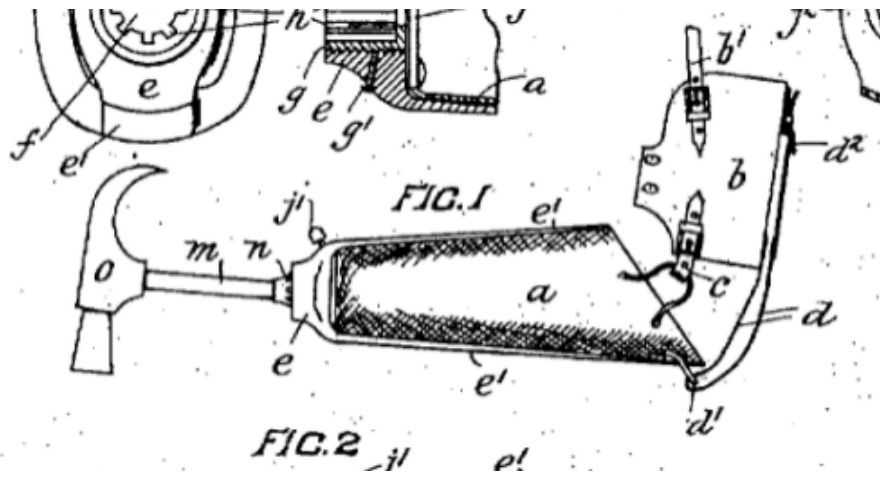

Note: The diagram was taken from U.S. patent 1,213,222 (1917). The figure shows a limb with attachable appliances for use in various trades. This diagram presents an attachable hammer called the "hammer arm." Source: United States Patent and Trademark Office.

Appendix Figure A.6: Rehabilitated to Work (Part III)

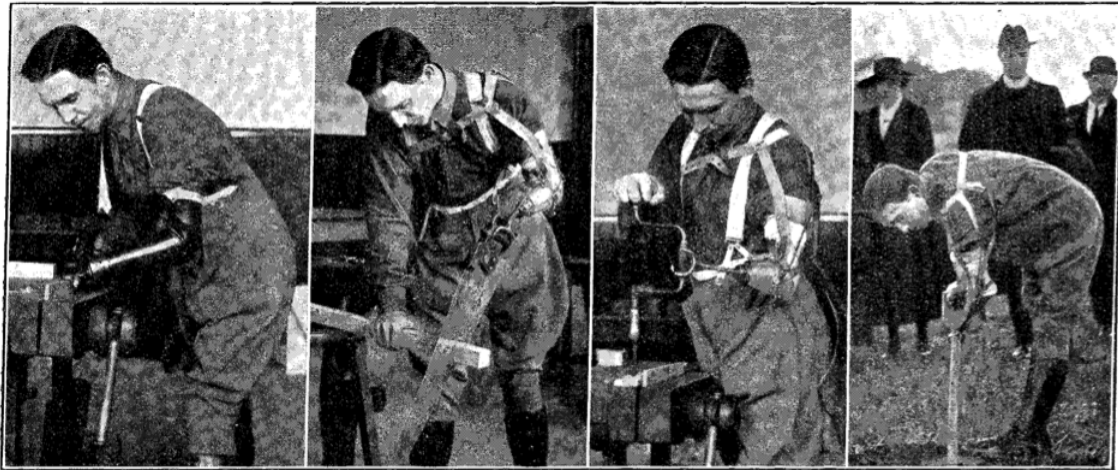

Note: The figure shows interchangeable appliances that equip wearers to perform various trades. Image included with permission from Elsevier: Marshall CJ. Modern artificial limbs: The work of the arm-training centre at Roehampton. *Lancet*. 25 June 1921.

Appendix Figure A.7: The Natural Hand vs Predominant “Carnes Hand”

(a) The Natural Hand

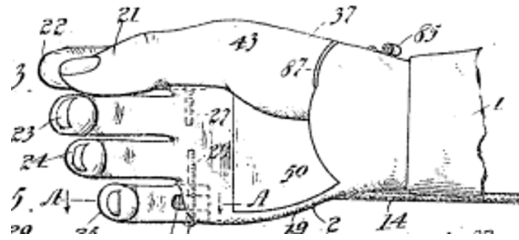

(b) The Carnes Hand

999,484.

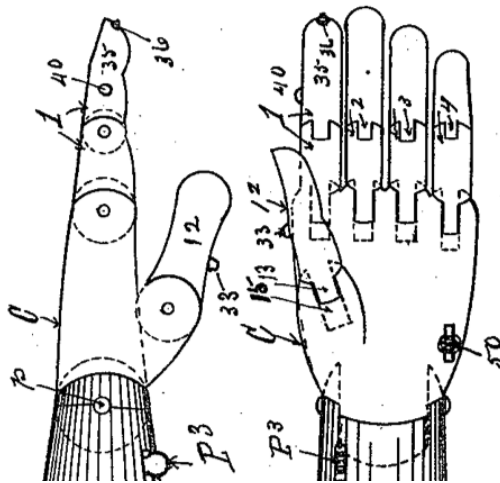

Note: The top diagram was taken from U.S. patent 1,173,219 (1915), and the bottom diagram was taken from U.S. patent 999,484 (1910). The figure contrasts a more naturally designed hand emphasizing “appearance” (top subfigure) against a more mechanical and modular hand (bottom subfigure). Source: United States Patent and Trademark Office.

Appendix Figure A.8: New Cheap Material

A. A. Marks,
Artificial Leg,
No. 40,763, *Patented Dec. 1, 1863.*

Fig. 2.

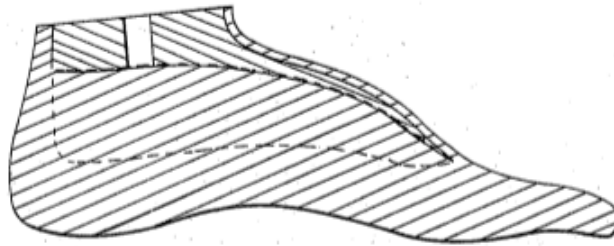

Fig. 1.

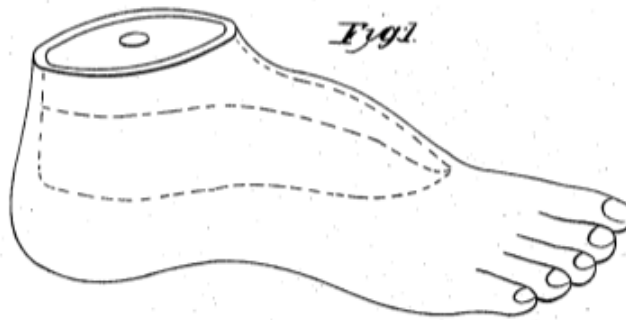
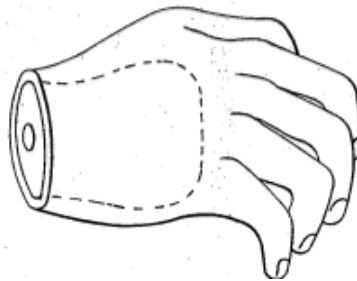
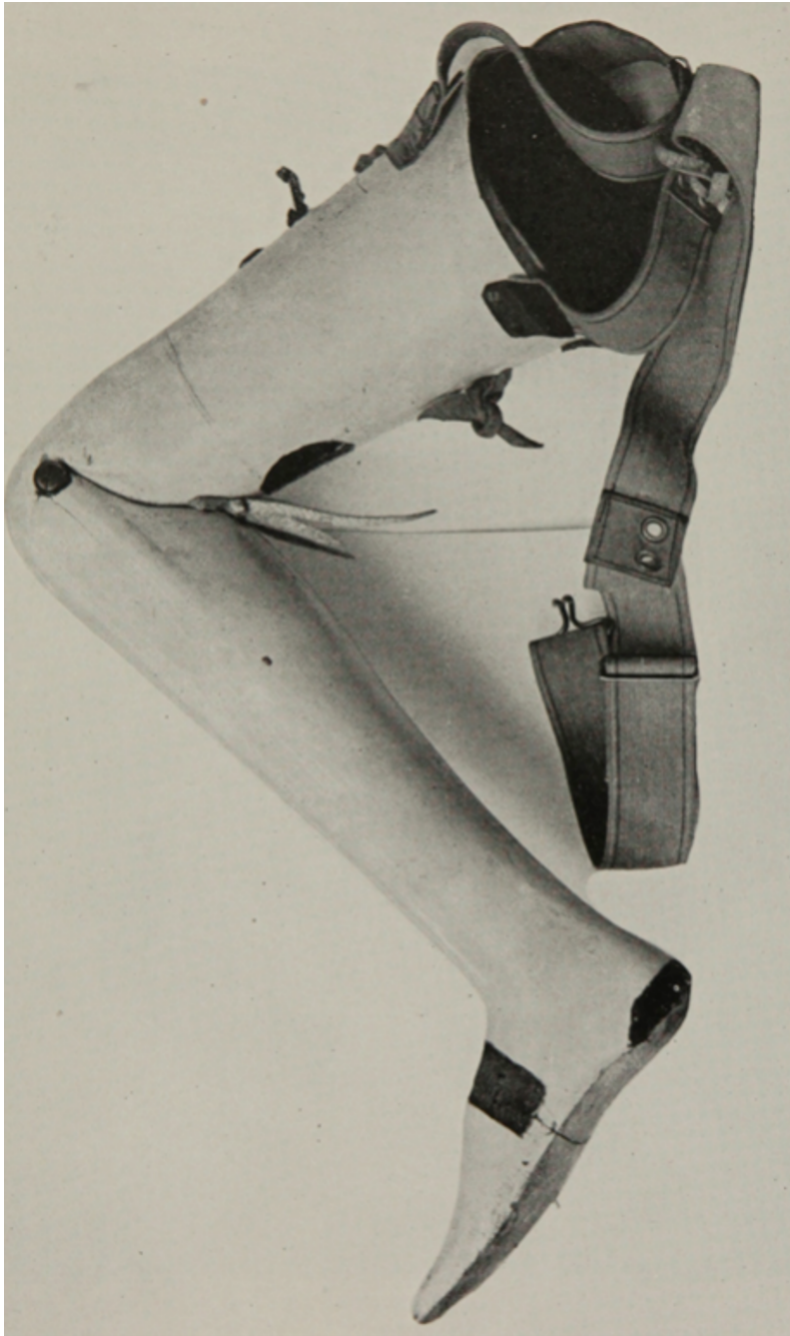

Fig. 3.



Note: The diagram was taken from U.S. patent 40,763 (1863). The figure shows a series of limb pieces constructed from a new, cheap material called vulcanized rubber. This allowed for the cheap construction of a variety of limb components. Source: United States Patent and Trademark Office.

Appendix Figure A.9: Cheap, Modular, and Life-Like Material



Note: This figure presents the “liberty limb,” an artificial leg constructed with a fleshy-colored material and was modular in nature. Source: The United States Army Surgeon General’s Office, *The Medical Department of the United States Army in the World War*, Washington, DC: GPO, 1927, volume 11, page 741.

Appendix Figure A.10: Adjustable Limb

J. MONROE.
LACER FOR KNEE BRACES, &c.
No. 66,728. Patented July 16, 1867.

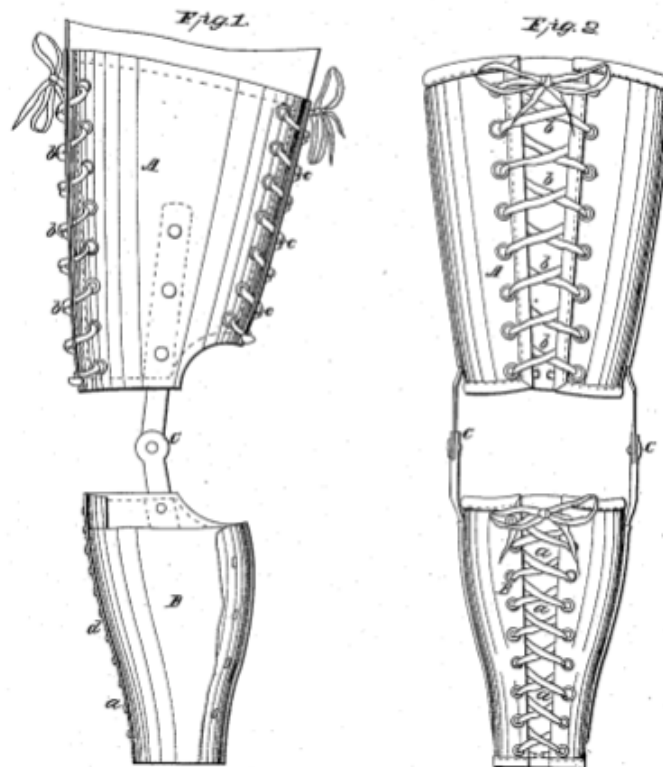

Witnesses:
W. H. Hays
Frederick West

Inventor:
Joshua Monroe

Note: The diagram was taken from U.S. patent 366,728 (1867). The figure shows a lacer device that allows users to adjust knee braces to their unique specifications, lending to cheaper, uniform limb construction. Source: United States Patent and Trademark Office.

Appendix Figure A.11: Adjustable Limb II

G. B. Jerrett,

Artificial Leg.

N^o 35,937.

Patented July 22, 1862.

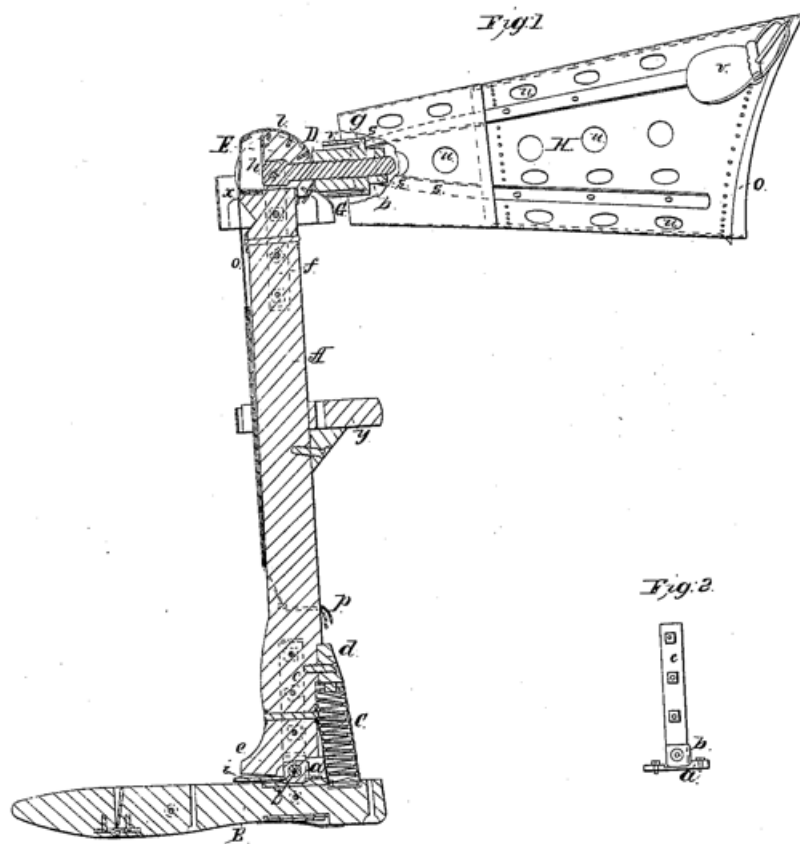

Note: The diagram was taken from U.S. patent 35,937 (1862). The figure shows an artificial leg with an adjustable height, which relies on an extending spindle in the knee joint. Such a design allows cheaper, uniform construction of limbs, avoiding more expensive, tailored construction. Source: United States Patent and Trademark Office.

Appendix Figure A.12: Naturally Simple Limb

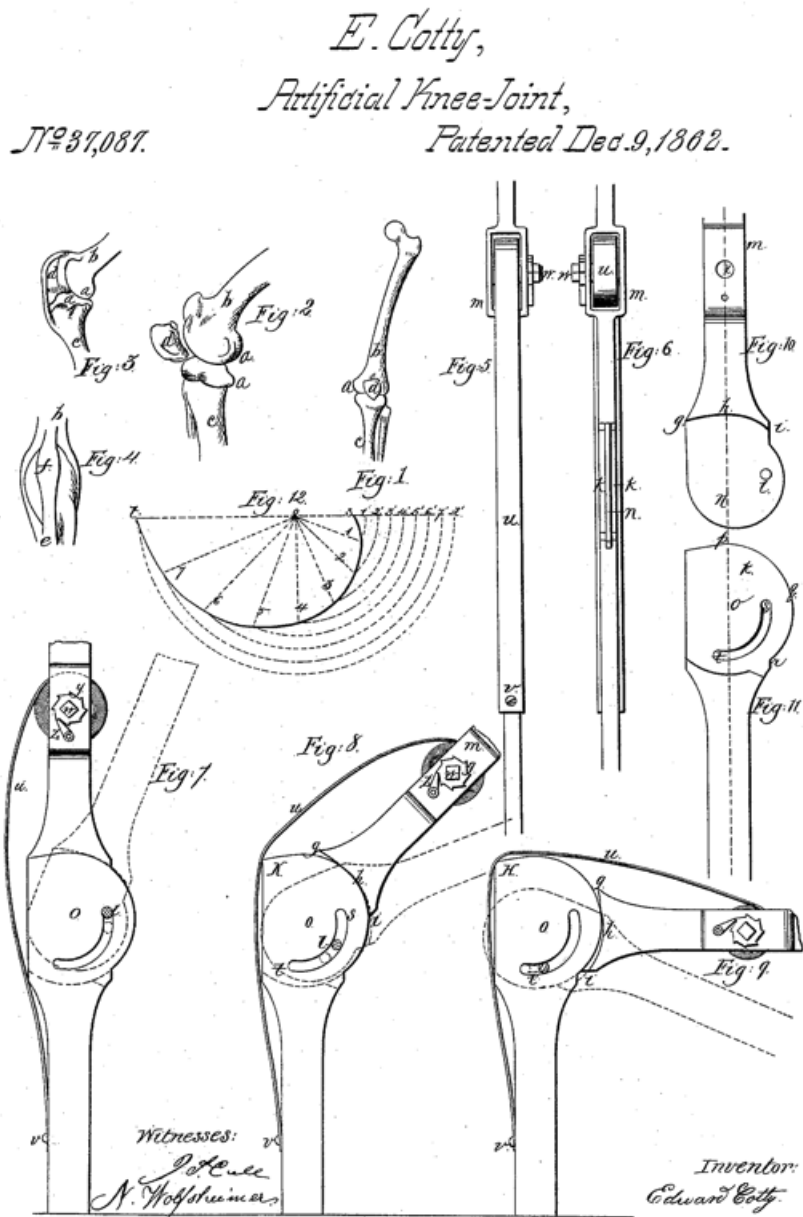

Note: The diagram was taken from U.S. patent 37,087 (1862). The figure shows a knee joint constructed of only two primary components, with a simple hinge component at the knee. More complex knee joints, such as the one shown in figure A.13, use more intricate mechanisms. Such simplicity allowed for ease of mass production. Source: United States Patent and Trademark Office.

Appendix Figure A.13: More Complex Knee Joint

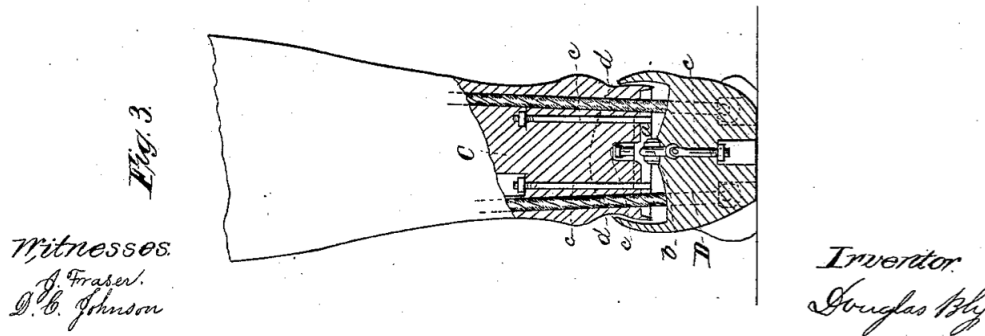

Note: The diagram was taken from U.S. patent 38,549 (1863). The figure shows the internal workings of a more complex knee joint invention that emphasized appearance and comfort. Source: United States Patent and Trademark Office.

Appendix Figure A.14: Cheap Bucket Limb

D. D. Parmelee,
Artificial Leg.
N^o 37,637. Patented Feb. 10, 1863.

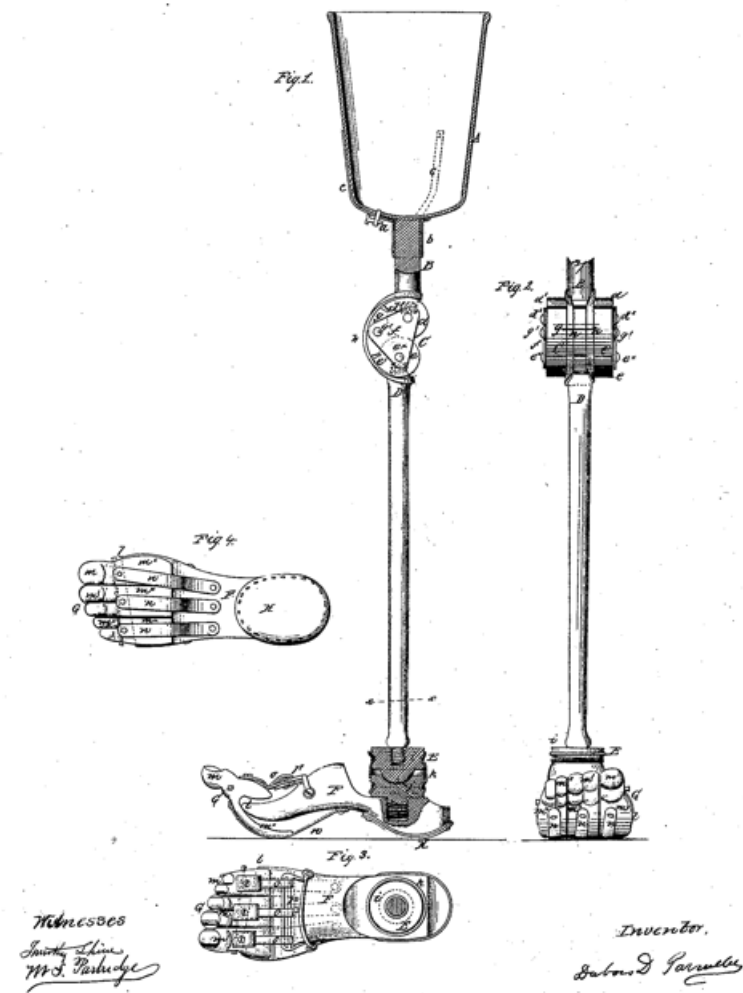

Note: This diagram was taken from U.S. patent 37,637 (1863). The figure shows a unique bucket design for the apparatus into which the stump is inserted. The bucket construction allowed the limb to be adjusted to different user specifications allowing for cheap, uniform construction. Source: United States Patent and Trademark Office.

Appendix Figure A.15: Cheap Metallic Limb

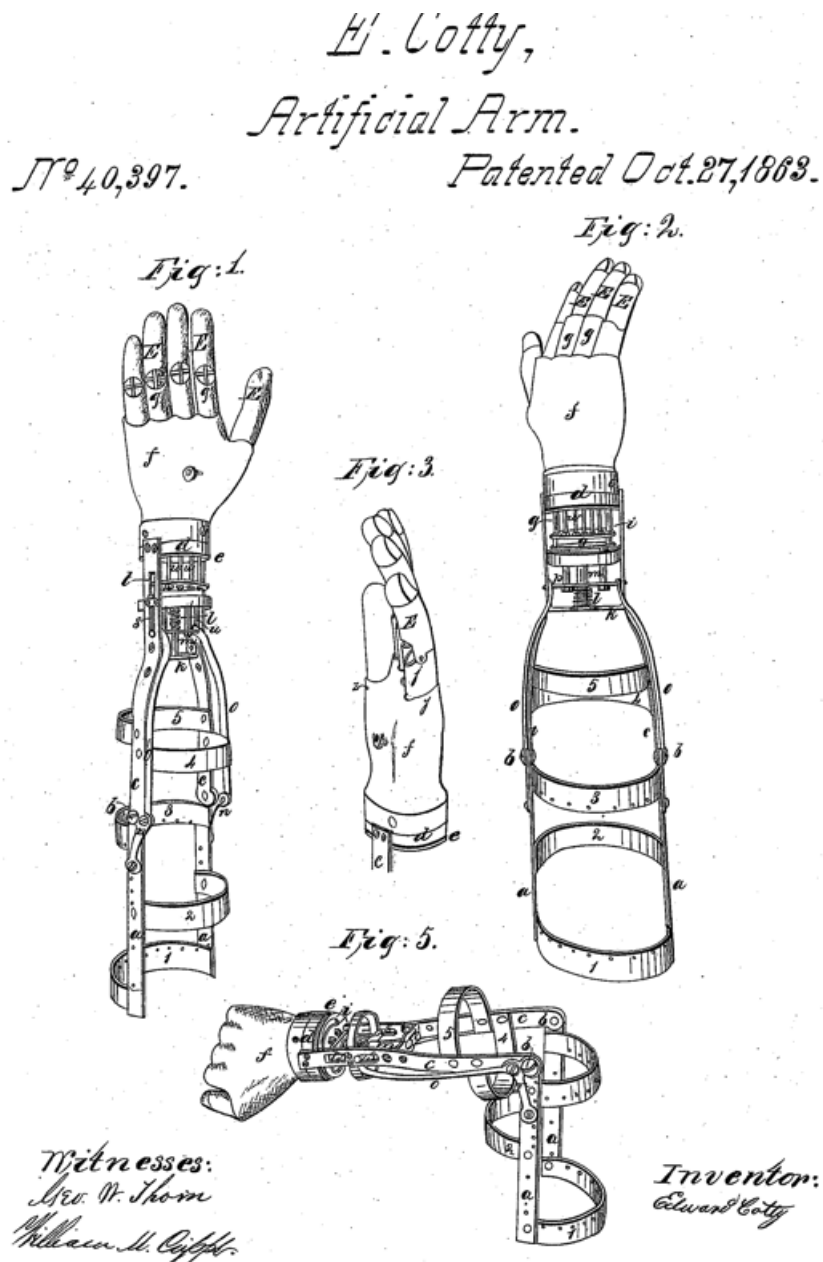

Note: This diagram was taken from U.S. patent 40,397 (1863). The figure shows the use of metal materials when constructing the forearm section of the prosthetic arm in an effort to reduce production costs. Source: United States Patent and Trademark Office.

Appendix Figure A.16: Comfortable Limb Casing

J. W. Weston,
Artificial Leg,
N^o 53,206, *Patented Mar. 13, 1866.*

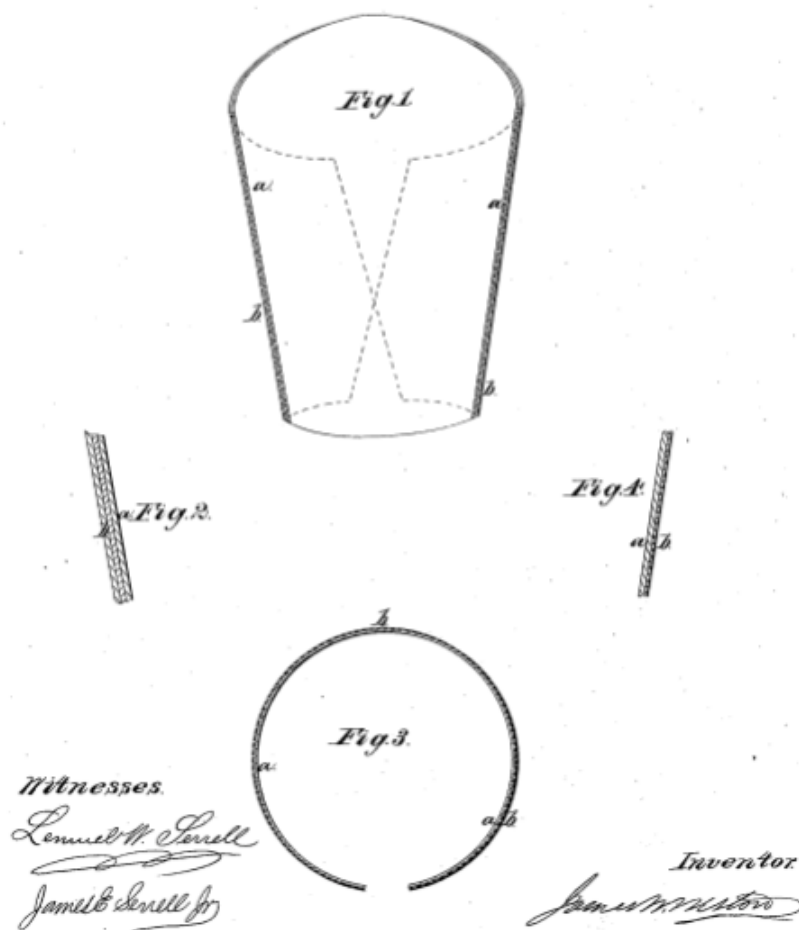

Note: This diagram was taken from U.S. patent 53,206 (1866). The figure shows the construction of a cork limb casing designed to wick away moisture and perspiration. Source: United States Patent and Trademark Office.

B Text Analysis Appendix

In this appendix we discuss our approach to designing, evaluating, and selecting our preferred machine learning algorithm for analyzing the texts of patent documents. We begin by describing our objective and comparing our setting with other uses of text analysis in economics research. We then define key terms and discuss examples of the key threats to successful text analysis, along with our approach to addressing them. Finally, we discuss several dimensions of best practice text analysis.

B.1 Generating Economic Data through Text Analysis

Our goal in conducting text analysis is to create variables that describe the economic content of patent texts. Specifically, we analyze the texts of prosthetic device patents, other medical patents, and mechanical patents to determine whether they emphasize traits we term simplicity, cost, adjustability, materials, comfort, and appearance. We code these traits as binary variables, which are our text analysis outputs.

Our text analysis task shares several key commonalities with recent “sentiment” and “partisanship” analyses, where the objective is to rate the sentiment or the degree of partisanship of a publication, writer, or speaker (Shapiro, Sudhof, and Wilson, 2018; Shapiro and Wilson, 2019; Garcia, 2013; Gentzkow, Shapiro, and Taddy, 2019; Gentzkow and Shapiro, 2010).²⁴ Key commonalities are as follows. First, the researcher must either obtain or create a data set containing a set of outputs (the “true values” for the variables of interest) corresponding to a set of text inputs (a subset of the texts of interest). A machine learning algorithm then learns a function, or model, that relates these input-

²⁴Similarly motivated text analysis exercises have also been used quite recently to study patents. Dechezlepretre, Hemous, Olsen, and Zanella (2019), for example, use a keyword search approach to code patents based on whether they relate to “automation.” Cockburn, Henderson, and Stern (2018) similarly use a keyword search approach to track the advance of artificial intelligence through references within patent texts and journal articles.

output pairs. Cross-validation is used to evaluate the model's performance by splitting the manually coded input-output pairs into two sets: one on which the model will be trained and another on which the model's performance will be tested. The train-test split is crucial for reliably evaluating performance, as testing on the same data used for training will tend to produce overly optimistic results due to over-fitting.²⁵ The selected predictive model is then used to assign values for the output variables of interest to the full set of text inputs. Note that these methods are typically used because resource limitations prevent researchers from closely reading and manually coding true values for the broader set of texts. In our case, for example, the broader set of texts consists of more than 700,000 patent documents.

Our preferred algorithm can be described as a modified supervised machine learning algorithm. Our algorithm is somewhat analogous to algorithms used for sentiment analysis by Shapiro, Sudhof, and Wilson (2018). Straightforward algorithms for sentiment analyses make use of "lexicons" that assign positive and negative values to the sentiment associated with extensive lists of words. A simple "Lexical Methodology," for example, is to assign a document a sentiment score based on the sum or mean of the values assigned to the words in its text by the lexicon. In our setting, this is analogous to determining that a patent emphasizes a particular economic trait if its text contains a keyword with which we associate that trait. Shapiro, Sudhof, and Wilson (2018) discuss how this basic approach can be improved upon through tools that account for context (e.g., "negation rules"). While the word "happy" conveys positive sentiment, for example, the phrase "not happy" conveys the opposite. A similar concern motivates the tool we design, which incorporates a neighborhood of contextual clues to root out false-positive errors.

²⁵Testing on the left-out data gives insight regarding how generalizable a model will be to new data. Further, repeating cross-validation using randomized train-test splits decreases the likelihood that high performance is simply a result of an opportunistic split.

B.2 The Central Problems of “Polysemy” and “Synonymy”

When using algorithms to extract economic information from text, researchers must overcome errors driven by the complexity of language. In particular, errors can be generated by variations in a word’s meanings across contexts and by similarities in the meanings of multiple words. These issues are commonly termed “polysemy” and “synonymy,” respectively (Scott Deerwester, 1990; Magerman, Looy, Baesens, and Debackere, 2011).

Synonymy (multiple words having the same meaning) can lead to false negatives, as an algorithm may fail to account for words that are similar in meaning to an attribute’s most intuitive keywords. By contrast, polysemy (when words have multiple, context-dependent meanings) elicits false positives. If an algorithm does not detect a word’s distinct contextual meaning, it may falsely connect a text input with the concept of interest (Turney and Pantel, 2010). Polysemy can take multiple forms. In some cases, a word’s meaning is straightforwardly negated by the words around it (e.g., the aforementioned difference between “happy” and “not happy”). In other cases, a word’s meaning may differ with the subject matter contained in the full text or in a particular sentence (e.g., the meaning of “fork” in the phrases “fork in the road” versus “knife and fork”). The difficulties posed by polysemy and synonymy can be closely related, as a keyword’s contextual meaning cannot be learned if the keyword itself is not initially detected.

B.3 Illustrative Examples from Patent Texts

The attributes we analyze exhibit varying degrees of “polysemy” and “synonymy.” The attribute we term “simplicity,” for example, was relatively straightforward. This is because the language linked to “simplicity” is relatively common across texts; it is unlikely to have ambiguous meaning or numerous synonyms. One prosthetic device

patent, for example, quite explicitly stated that “The object of my invention is to imitate this eccentric motion of the knee-joint in the simplest manner.” Another states, “The advantages of my invention are as follows: ... great simplicity, and therefore cheapness.” The meaning of simplicity extended quite well to patents in our control classes. One such patent highlights, for example, “that the machinery which we use, as hereinafter described, is simple in construction.” The relative ease of classifying simplicity is shown in the high performance, which we define more precisely below, we obtain when training the models we consider. Notably, our preferred model performed quite well in predicting “simplicity” even when the training set contained as few as 100 observations.

By contrast, the attribute we term “comfort” was relatively difficult to work with. Difficulties arose because the language used to indicate a product’s “comfort” regularly suffered from ambiguity. Sometimes, the meaning of comfort was quite clear. A straightforward example from prosthetics states “My present invention has for its object the production of an artificial leg constructed on such principles that it will give more strength and durability to the limb, and also ease and comfort to the wearer.” A straightforward true positive from a different mechanical class states that “Until the external pressure becomes too great... air [is] allowed to enter the box A, until the person sitting in it feels comfortable.” Difficulties arose, however, from polysemous words used to describe discomfort. For example, the word “disturbing” often connotes bodily discomfort in prosthetic device patents. In mechanical classes, by contrast, the word “disturbing” tends to have meanings connected to the device’s functionality (e.g., “disconnecting or disturbing the pump”). The difficulties created by such cases translated into poor predictive accuracy when we attempted to train our preferred model on relatively small training sets.²⁶

²⁶As discussed below, comfort is a trait for which accuracy experienced substantial gains as the size of our training data set increased.

B.4 Assessing a Model's Accuracy

A model's accuracy in a binary classification problem can be well described by the evaluation metrics of "sensitivity" and "specificity." Sensitivity refers to the rate of true positives as a share of all positives, while specificity refers to the rate of true negatives as a share of all negatives. These metrics were particularly well suited for our study as they directly ascertain an algorithm's ability to confront the issues of polysemy and synonymy.

Sensitivity and specificity are related. When specificity is reasonably high, sensitivity measures how well an algorithm addresses synonymy by directly revealing the algorithm's ability to correctly detect the desired characteristics: If included keywords inadequately detect patent characteristics due to excluded synonymous keywords, sensitivity would be low. Whereas, when sensitivity is reasonably high, specificity measures the algorithm's ability to ascertain a keyword's context-specific meaning: If the algorithm correctly detects the absence of a given characteristic in the presence of a keyword, it is identifying contextual cues that nullify a keyword's relevance, causing specificity to increase. If either sensitivity or specificity is very low, however, then the algorithm may arbitrarily assign positive or negative outcomes depending on which outcome occurs most frequently in the training data.

The simple average of sensitivity and specificity is commonly termed the "balanced accuracy score." The balanced accuracy score, averaged across "repeated 10-fold cross-validations," is the criterion we use for model evaluation. We used balanced accuracy, as opposed to other evaluation metrics, as it accounts for class imbalance in the dependent variable—a potential issue common in binary classification tasks.²⁷ As a rough rule of

²⁷In the context of a binary classification problem, class "imbalance" means that there are more/fewer negative outcomes compared to positive outcomes. See Brodersen, Ong, Stephan, and Buhmann (2010) for a widely cited discussion of the balanced accuracy score's attractive properties in settings where this holds.

thumb, we targeted balanced accuracy scores of at least 90 percent.²⁸ As shown below, however, incremental improvements in an algorithm’s accuracy can have meaningful implications for a research project’s estimates of primary interest.

We contrast the performance of our preferred model with models generated by a variety of alternative algorithmic techniques. In cases where text classification is well defined by a set of important words, a natural benchmark for assessing alternative tools is a keyword search. A keyword search algorithm codes patents as emphasizing a particular trait if the document contains any words that are strong markers for the trait. As highlighted below, a keyword search is highly effective at identifying positive outcomes for tasks like ours. It may produce false positives, however, by ignoring contextual cues that nullify a keyword’s relevance. Whether this shortcoming outweighs a keyword search’s ability to detect positive outcomes depends on the degree of polysemy in a researcher’s particular task.

B.5 Our Preferred Algorithm: A Novel Modified ML Approach

We considered several classes of algorithms as potential tools for constructing our data set. These included “unsupervised” machine learning algorithms, “supervised” machine learning algorithms, modified supervised learning algorithms, and simple keyword searches. Our preferred algorithm can be described as a modified supervised learning algorithm. The key modification, which involves constraining the feature space from which the algorithm learns, generated advantages with respect to both accuracy and computing requirements.

Unsupervised learning tools are meant to form meaningful groupings of input data

²⁸Another common measure of model performance in binary classification tasks is AUC, the area under the receiver operating characteristic curve. For our “comfort” trait we achieve an AUC score of 0.92 and for our “simplicity” variable we attain an AUC score of 0.95. These scores are quite high, suggesting that positive and negative outcomes are quite distinctly separated as the majority of outcomes are simply determined by the presence of a keyword.

based on some predefined metric (Atthey, 2018). In our context, we found that such tools struggled to form groupings that coalesced around the economic attributes we sought to analyze. This problem cannot be resolved through the analysis of larger samples.

Standard supervised machine learning tools take as inputs a feature space generated from the entirety of each document’s text. We find that these tools struggled to overcome the problems of synonymy and polysemy.²⁹ For supervised machine learning tools, we find that the performance of existing algorithms improved, to varying degrees, as we expanded the size of our training set. It is thus possible that these algorithms would reach tolerable accuracy thresholds on training samples of sufficient size. Our analysis is suggestive, however, that generating training samples of sufficient size may be beyond many research projects’ scope. Closely reading thousands of patent texts or other context-relevant documents is a resource-intensive process.

We find that simple keyword searches performed quite well in our setting. Notably, the development of our lists of keywords benefited from our experimentation with machine learning. In our project’s early stages, we attempted keyword searches based on a combination of intuition and close readings of a small set of patents. This “procedure” performed poorly. The accuracy of our keyword searches increased substantially as we learned more about our domain through close readings of 1,200 patent documents in total. Success with either keyword searches or our modified machine learning approach will tend to require substantial knowledge of the domain one is attempting to analyze.³⁰

²⁹This may stem from the fact that even after processing the text data (removing stop words, word fragments, etc.), the full sample of patent texts contained over 18,000 features. In a simulation analysis using synthetic data, Hua, Xiong, Lowey, Suh, and Dougherty (2004) simulate error rates across alternative feature space sizes, sample sizes, and algorithms. In their context, they find that the optimal feature size is $N - 1$ for uncorrelated features (where N is the sample size) and that the optimal feature size becomes proportional to \sqrt{N} for highly correlated features. Although these findings are not necessarily generalizable, in our case the number of features (when using the full processed patent texts) was $15N$, suggesting that the relatively high number of features is plausibly linked to suboptimal performance.

³⁰The success of our modified machine learning tool depended on a combination of manually gathered keywords through close readings and data-driven synonym determination. Although this form of feature selection required extensive domain knowledge, feature selection can be effectively executed using entirely

Both sets of approaches provide ample evidence of the idiom “garbage in, garbage out.”

Although keyword searches ultimately performed quite well for our task, their general limitations are worth emphasizing. A keyword search does not, by construction, allow context to inform a word’s meaning. This can lead to false-positive errors. In general, it should thus be possible to improve upon keyword searches by allowing contextual clues to inform a word’s true meaning within each text.

Our preferred, modified approach connects the knowledge we obtained reading patent documents to the Gradient Boosted Machines algorithm (Friedman, 2001).³¹ When constructing this model we directly targeted the issues of synonymy and polysemy. First, while reading 1,200 patent documents, we compiled a non-comprehensive list of keywords that indicate each characteristic. To gather each keyword’s synonyms, we mapped all our considered patent text corpora to a vector space.³² This allows us to model the degree of contextual similarity between words using spatial word proximity, resulting in spatial groupings of keywords and their most relevant synonyms. After adding keywords and their synonyms into the feature space, we then include a flexible neighborhood of text surrounding these words to provide contextualization.³³ We then train the machine learning algorithm with this reduced feature space to obtain more

data-driven algorithms (see Guyon, Weston, Barnhill, and Vapnik (2002) and Guyon and Elisseeff (2003)). In our case, however, these purely data-driven approaches selected features that induced worse performance than simply using the full patent text. Accuracy gains only occurred when we used a combination of hand-picked and data-driven feature selection.

³¹This is a “boosted” version of Random Forests (Breiman, 2001) where error terms from previous decision tree predictions inform the construction of subsequent trees.

³²We use Word2Vec (Mikolov, Sutskever, Chen, Corrado, and Dean, 2013) to construct these word embeddings. Word2vec uses shallow neural networks to map words within text documents to a vector space that captures word relationships through a distance metric. Words within this space are mapped as being close together if they occur in similar contexts in the text corpora.

³³These steps are well described as a type of “feature selection.” Feature selection has been shown to help at “improving the prediction performance of the predictors, providing faster and more cost-effective predictors, and providing a better understanding of the underlying process that generated the data” (Guyon and Elisseeff, 2003),

accurate and efficient results.³⁴

Relative to alternative machine learning methods, our modified approach generated accuracy gains when predicting each of our economic characteristics. Improvements relative to machine learning approaches that attempt to learn from the entirety of each patent’s text were quite large. The relative success of our modified approach, when compared to other pure machine learning methods, is driven by the amount of extraneous information in patents’ full texts, figure descriptions, and detailed claims. The presence of extraneous features reduced these algorithms’ ability to pinpoint specific, economically relevant patent characteristics. Constraining the feature space to include only keywords, their synonyms, and neighboring contexts allows the machine learning algorithm to learn more efficiently.

Relative to a keyword search, our algorithm’s greatest improvements in accuracy were gains of three percentage points for the quality-oriented traits we term “comfort” and “appearance.” The improvement in accuracy comes entirely from gains in specificity: The modified approach learns to discriminate keywords whose context nullifies their meaning. Although a three percentage point gain in accuracy is modest, researchers will tend to realize larger gains for text analysis problems with greater degrees of polysemy.

B.6 Lessons for Implementing Best Practice Text Analysis

In this section, we illustrate several key inputs to best practice text analysis. While text analysis tasks necessarily confront many setting-specific challenges, the dimensions of best practice we discuss should apply quite generally. They include an approach for assessing the optimal size of a training set, the importance of generating a training

³⁴Computation time was dramatically reduced using our approach when compared to other machine learning algorithms. This stems from the reduced feature space, allowing quicker model training.

set that covers all contexts that a researcher targets, and an approach for assessing the implications of inaccurate predictions for the estimates in which a study is ultimately interested.

B.6.1 Determining Optimal Sample Size

We conducted a systematic analysis of how the performance of various algorithms evolved as we expanded the size of our training data set. Text analysis tasks may differ substantially with respect to the complexity of each piece of text and with respect to the severity of setting-specific sources of polysemy and synonymy. Consequently, it is not possible to prescribe a “rule-of-thumb” size for a training set. One can nonetheless use the relationship between accuracy and sample size to make inferences regarding the returns to further expansions of the training set.

Using our preferred modified approach, the size of the training set required to reach tolerable balanced accuracy scores varied across traits. For the trait we term simplicity, for example, our balanced accuracy score exceeded 90 percent with training sets containing fewer than 200 observations. For the trait we term comfort, by contrast, the accuracy score approached 90 percent as training sets contained roughly 700 observations. For the trait we term materials, the accuracy score remained below 90 percent even on our full training set of 1,200 observations.

On what basis should the size of the training set be determined? Expanding a training set requires project resources. On the margin, the key question is whether increases in the size of the training set yield non-trivial returns. As a way to gauge the relevant returns, we recommend constructing “learning curves,” like those displayed in Figure B.3. We constructed these figures by evaluating our model’s accuracy when trained and tested on samples of varying sizes. More specifically, we executed a bootstrap estimation of our model’s balanced accuracy score when trained on different sample

sizes from our manually coded data, with the remaining un-sampled data forming the test set. The solid green line in each panel traces the mean of the balanced accuracy score across 400 iterations of this procedure at ascending sample sizes. The shaded green area extends from the 10th to the 90th percentiles of the distribution of results. The bootstrap approach assures that our estimate for any given sample size is not skewed by particularly “favorable” or “unfavorable” draws, meaning draws on which the algorithm happens to have a particularly easy or difficult time with its prediction task.

Panel A of Figure B.3 shows that the balanced accuracy score for “comfort” is relatively low with small samples. Further, the score for comfort exhibits non-trivial improvement as the training set expands to include as many as 1,000 patents. The band extending from the 10th to the 90th percentiles of the distribution is quite large in comparison with the band presented in panel B, for the trait we term simplicity.

Panel B of Figure B.3 shows that the balanced accuracy score for “simplicity” is high with small samples. Further, the score asymptotes quickly. It exhibits no further improvement once the training set includes 400 observations. Notably, the band extending from the 10th to the 90th percentiles of the distribution is relatively tight. This further supports the point that the performance of the algorithm is not particularly dependent on the patent documents used to train it.

Our analysis of alternative machine learning algorithms provides additional evidence that performance can depend crucially on sample size. On samples of the sizes we consider, we found that non-neural network machine learning algorithms perform better than deep learning algorithms and that our modified machine learning approach performs better than both deep learning and non-neural network machine learning models trained on the entire text of each patent.³⁵

³⁵These results are fairly consistent across the economic traits we analyze. All machine learning hyperparameters are tuned using randomized grid-search methods (Bergstra and Bengio, 2012). Deep learning models we considered were Bidirectional Encoder Representations from Transformers (Devlin, Chang,

B.6.2 Assessing the Stability of Economic Estimates

What constitutes an acceptable accuracy threshold? Alternatively, how can one gauge the implications of incremental changes in model accuracy for the primary estimates of an analysis? We shed light on this question through a simulation of how our estimates evolve as we systematically *reduce* the accuracy of our preferred algorithm’s estimates.

The procedure we conduct is straightforward. Starting with the data generated by our preferred modified approach, we inject noise by altering the coding of a given fraction of the observations for an outcome variable of interest. We do this for fractions ranging from 1 percent to 50 percent. We select the observations we miscode at random, then estimate β_1 from equation (4). As in our analysis of “learning curves,” we implement a bootstrap-style procedure. That is, for each degree of noise, we repeat the basic procedure 40 times to generate a range of new estimates. Figure B.4 reports the resulting means and distributions.³⁶

Panel A of Figure B.4 presents estimates for the trait we term “comfort” during the World War I period. Our baseline estimate for comfort is -0.14, indicating that wartime prosthetic device patents were 14 percentage points less likely than pre-war prosthetic device patents (net of the equivalent change for the synthetic control group) to emphasize comfort. As we reduce the accuracy of our comfort variable’s coding, this estimate quite rapidly converges towards zero. The magnitude of the estimate for comfort was halved before we had reduced accuracy by 10%.³⁷

Lee, and Toutanova, 2018), Convolutional Neural Networks (Kim, 2014), Recurrent Neural Networks with long short-term memory (Hochreiter and Schmidhuber, 1997), and Multi-Layer Perceptrons (Rosenblatt, 1961).

³⁶Note that the estimate we produce using the data generated from our preferred model serves as the benchmark. Since our modified approach does not predict with perfect accuracy, the current observations already have a small amount of measurement error corresponding to the error associated with the model’s performance in predicting “comfort.”

³⁷As the accuracy of the data approaches 50%, the estimate converges to zero. As the algorithm’s accuracy dips below 50% the estimate will begin to converge to the opposite sign of the true estimate. To

Panel B of Figure B.4 presents the sensitivity of estimates of β_1 from equation (4) for “simplicity.” Our baseline estimate for simplicity is 0.13, indicating that wartime prosthetic device patents were 13 percentage points more likely than pre-war prosthetic device patents (net of the equivalent change for the synthetic control group) to emphasize simplicity. Interestingly, the rate of convergence to zero differs non-trivially when comparing the estimates for comfort and simplicity. Estimates for simplicity converge more slowly, as the magnitude of the estimate is halved when we had reduced accuracy by roughly 20%.

Coding accuracy is clearly important for generating unbiased estimates in analyses of both comfort and simplicity. In both cases, 20% reductions in accuracy would render the estimates from our analyses much smaller economically. In addition to being economically smaller, the attenuated estimates are less likely to be statistically distinguishable from zero. Differences in the rate of convergence towards zero suggest that the tolerability of error may be higher in the case of simplicity than in the case of comfort. It is not obvious why this is the case. A natural hypothesis, into which more research is needed, is that estimates’ sensitivity to reductions in accuracy may depend in part on a trait’s baseline prevalence within both the treatment and control groups.

B.6.3 Context Specificity

The performance of a trained model may be limited outside the context of its training data. We term this concept “context specificity.” Limitations on a model’s validity outside of its training set can result from variations in word meanings and usage across domains and across time. In our case, a model trained to recognize the traits in artificial limb patents may perform poorly when applied to patents from classes we use as con-

see why note that altering the coding of 100% of the observations would yield a variable that is the inverse of the original variable.

trols. A model’s performance might be impaired if the training set lacks sufficient data from all considered domains.

To illustrate this point, we conduct the following exercise. Our data can be described as consisting of four contexts, namely Civil War-era prosthetic devices, Civil War-era control categories, World War I-era prosthetic devices, and World War I-era control categories. We train our model on a single context, then assess its accuracy in all four contexts. Doing this for each of the contexts separately generates a total of sixteen balanced accuracy scores, four of which involve applying the model to the context on which it was trained. To ensure that differences in accuracy scores across contexts are not driven by differences in sample size, we constrain the size of the training set to be equal in all cases.

The results of conducting this exercise for our “comfort” and “simplicity” traits can be found in Table B.1. In each panel, the main diagonal of the matrix of balanced accuracy scores corresponds to our model being applied to the context on which it is trained. This is done using cross-validation within the given domain and time period. The antidiagonal entries correspond to our model being trained on a different patent class (prosthetic devices vs. the control classes) and historical episode (Civil War vs. World War I) than the corresponding left-out test data set. Differences in the average value of the balanced accuracy scores along the main diagonal relative to the antidiagonal provide information on the relevance of context-specificity.

Consistent with our priors, we find that context-specificity is more important for traits for which the problems of polysemy and synonymy are relatively severe. In the examples presented in Table B.1, we find that the difference in accuracy scores when comparing the main diagonal to the antidiagonal is greater for “comfort” than it is for “simplicity.” The differences in accuracy scores for comfort are non-trivial. On average, the score along the main diagonal is 92.5 percent, while the average score along the

antidiagonal is 86.5. The difference of 7 percentage points is non-trivial when put in the context of our analysis from the previous section. For comfort, injecting a 7 percentage point reduction in accuracy led our estimate of β_1 from equation (4) to decline by nearly half.

More generally, we find that it is important to account for context specificity when predicting attributes whose meaning is domain- and time-dependent. In our setting, attributes that exhibited this time- and domain-dependence include “appearance”, “materials”, and “comfort.” By contrast, accuracy scores were relatively insensitive to the training set’s context for the traits we term “cost,” “simplicity,” and “adjustability.”

B.6.4 Acknowledging Limitations

In some cases, even a well-chosen algorithm trained using a large data set may yield low accuracy scores. Even with our preferred algorithm, for example, we obtained an accuracy score of 87 percent when predicting the trait we term materials. What drives this result and how should it shape our presentation of the evidence?

“Materials” was a difficult trait to predict because keywords that describe the introduction of novel materials tend to have no previous mentions. When few observations contain a keyword, an algorithm’s opportunities to learn how best to classify out-of-sample observations with that keyword are limited. Keywords that were consistently used to describe new materials—like material, alloy, chemical, composition, or mixture—also tended to be used in the description of a device’s construction whether or not the associated materials were new. Further, new material innovations were relatively rare. They occurred in only six percent of the observations in our sample, resulting in a small number of reliable positive observations.

As shown earlier, reductions in model accuracy tend to attenuate our estimates. Properly interpreting our estimates thus requires knowing the accuracy of the model used

to generate the dependent variable. We recommend presenting two key pieces of information. First, analyses of this sort should present readers with an accuracy metric that is appropriate to the setting.³⁸ In Table B.2, for example, we present the full set of balanced accuracy scores along with the underlying sensitivity and specificity scores. Second, “stability curves” of the sort we present in section B.6.2 provide valuable information for inferring the biases associated with inaccurate predictions. We thus recommend coupling these key pieces of information within a discussion of the implications of prediction errors.

In some cases, predictive accuracy may be sufficiently low that the resulting biases will lead point estimates to be highly misleading. In such cases, we recommend that readers be directly warned to interpret the estimates “with caution.” In some cases, it may be possible to pair this caution with the best estimate of the potential magnitude of the associated bias. If the only bias is a straightforward form of attenuation bias, then interpretable estimates can be recovered by applying a correction factor. If a correction factor cannot be estimated, the best approach may be to describe estimates as being useful for “illustrative purposes” only.

³⁸While the balanced accuracy score is a sensible metric for our setting, alternative metrics might be more suitable elsewhere.

Appendix Figure B.1: Flowchart of Modified Approach for Adjustability Characteristic

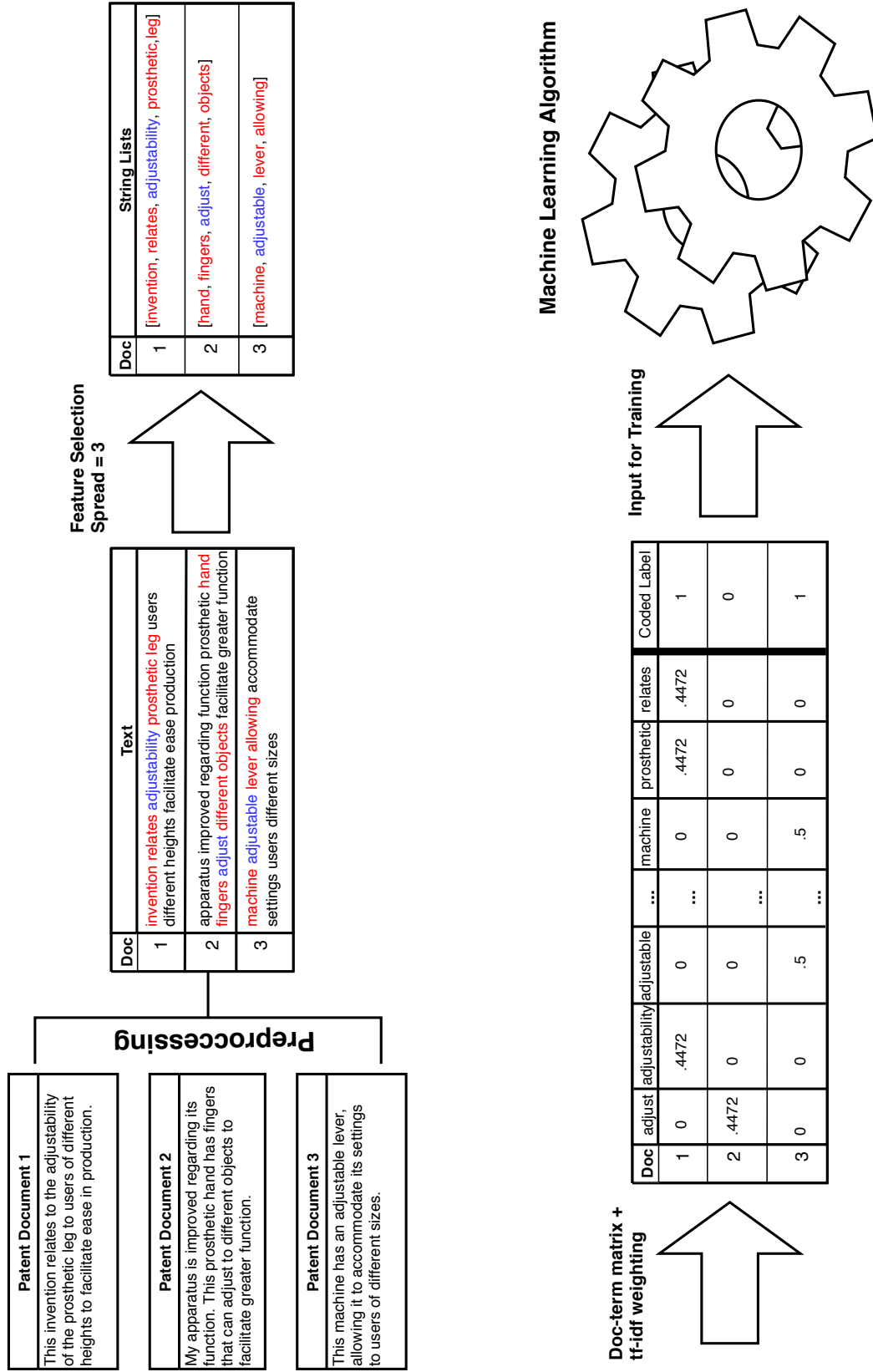

Note: The figure presents a flowchart of our modified approach. First, the text documents are preprocessed by correcting spelling errors, setting characters to lowercase, removing stop words, punctuation, word fragments, numbers, and extremely frequent or rare words. Then we select keywords and their surrounding context as features. After, we create a doc-term matrix with each entry representing the tf-idf weighting of relative importance. Lastly, this doc-term matrix is fed into the machine learning algorithm for training.

Appendix Figure B.2: Patent Document Example for “Comfort” with Spread = 3

UNITED STATES PATENT OFFICE.
v i GEORGE B. 'I.EVETT, OF SALEM, MASSACHUSETTS.
IMPROVEMENT IN ARTIFICIAL LEGS.
Speciication forming part of Letters Patent NO. 35,937, dated July 22, 1862.

erence being had to the accompanying draw- Y ing, making part of this specication, in which is represented my improved artificial leg, the parts from the knee-joint down being shown in section. Y

The improved artificial leg which is the subject of my present invention is intended to be applied in cases of amputation above the kneejoint, and is so constructed that its length may be easily and nicely adj usted to suit the wearer, it being foun'd in practice to be almost impos- l sible to make an artificial leg by measurement to be comfortable. In all other artiicial legs with which I am acquainted the spring which is applied at the knee-joint to straighten the leg when bent continues to exert its full strength when the wearer is sitting down and the thigh and lower leg are at right angles to each other. This is inconvenient, as the wearer is compelled to extend the leg instead of holdingit bent in a natural position. This I have remedied by my improved construction of knee-joint and the manner of applying the spring thereto.

That others skilled in the art may understand and use my invention, I will proceed to describe the manner in which I have carried it out.

In the said drawing, A is a straightslick of some strong wood, (which represents the tibia ofthe human leg,) to the lower end of which is hinged the foot-piece B, to which a certain amount of motion is allowed, as follows: the foot-piece B has attached to its top an iron plate, a, to which is hinged at b two metal straps, o, (shown detached in Fig. 2.) which are attached by suitable bolts or screws, one on each side of the piece A. A spring, C, is placed behind the piece A and presses against the heel of the foot and against a stop, d. As the weight is thrown upon the heel,this spring iscompressed, and as the step is completed a shoulder, e, on the front side of the piece A comes down onto an elastic pad, t', secured to the top of the foot-piece B, and limits the vibration of the foot on its pivot b. The thickness of this pad t may be varied to suit the length of step or stride of the wearer.

To the upper end of the piece A is attached, by bolts or screws, two metal straps, f, one on each side, (shown dotted,) to which is pivoted a metal spindle, D, on one end of which is cut a screw to receive a nut, g, and from the other end of which projects a plate, h, which, when the leg is straightened out, comes in contact with and rests on a pad, m, of leather or other yielding material, attached to the top of the piece A, which limits the motion of thejoint in one direction. This pad may be varied in thickness, so as to give a proper and natural movement to the leg. A block of wood, E, is attached to thespindle D,which passes through v Its outer side is circular and has a band It is also it. of metal, l, secured to it by screws. screwed to the plate h. pad, n, at the back of the piece A, against which a shoulder on theblock E strikes when the leg is brought into the position shown in the drawings. A spring, F, of elastic web bing or other suitable material,is connected at one end by a strap, o, of leather, to the metal wearer may sit down with his leg bent in a natural position without an effort being necessary to resist the power ofthe spring. The socket H, into which the stump is inserted, is connected with the spindle in the following manner: A circular block, G, of wood,is slipped over the spindle D, and a metal sleeve or cap, r, with a nut, g, in its 'topfits over the block and screws down onto it,-the screw on the the spindle turning in this nut. From this sleeve braces s (shown dotted) are connected with the metal shell or socket H. Two locknuts, 5 and 6, secure the parts when screwed down.

The block G may be changed for one of a different length, or a piece may be eut of' from it to adjust the leg to the proper length.....

Note: The figure presents a patent document example. We focus the machine learning algorithm’s attention to the keywords (blue) and the surrounding context (red). In this case spread = 3 and the trait of interest is “comfort”. We correct spelling errors using a preprocessing procedure.

Appendix Figure B.3: Learning Curve Balanced Accuracy Score

Panel A: Comfort

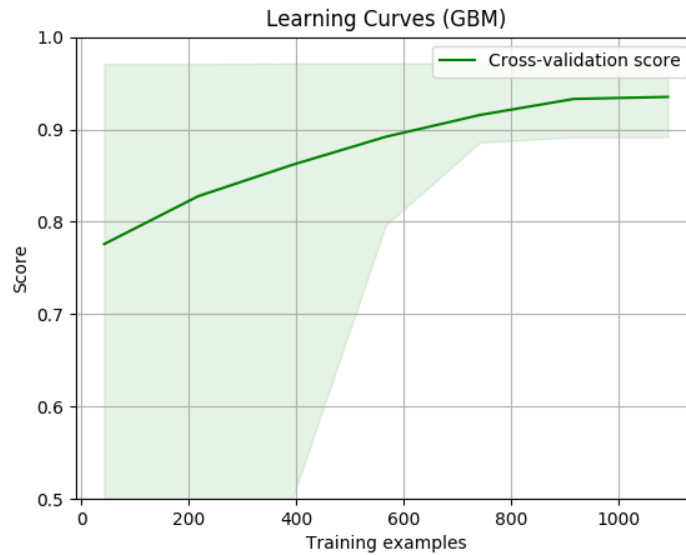

Panel B: Simplicity

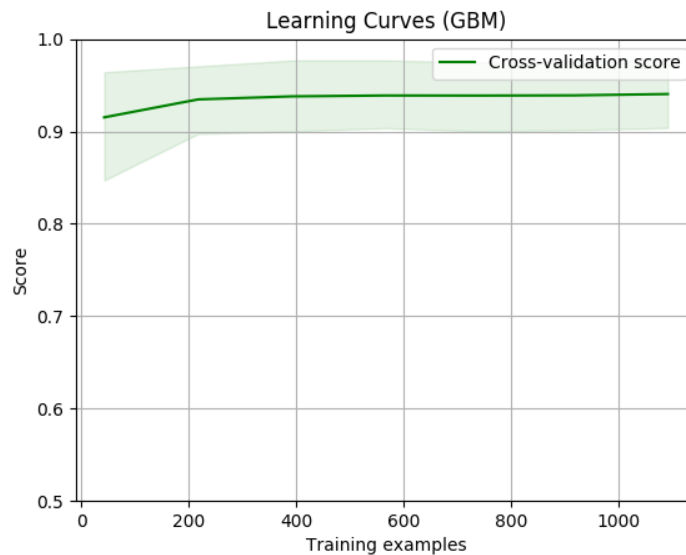

Note: The figure presents the “learning curves” for our preferred modified approach using a GBM algorithm when predicting the presence of our traits in patent documents. Panel A shows the learning curve for “comfort,” and panel B shows the learning curve for “simplicity.” The solid green line in each panel traces the mean of the balanced accuracy score across 400 iterations of a bootstrap cross-validation procedure at ascending sample sizes. Each bootstrap iteration randomly selects a training set of the “training examples” size to train the model, and the model’s accuracy is then tested on the remaining un-sampled data. The shaded green area extends from the 10th to the 90th percentiles of the distribution of results. Balanced accuracy is reported in decimals (0.9 = 90% correctly predicted).

Appendix Figure B.4: Estimate Stability To Reductions in the Accuracy Score

Panel A: Comfort

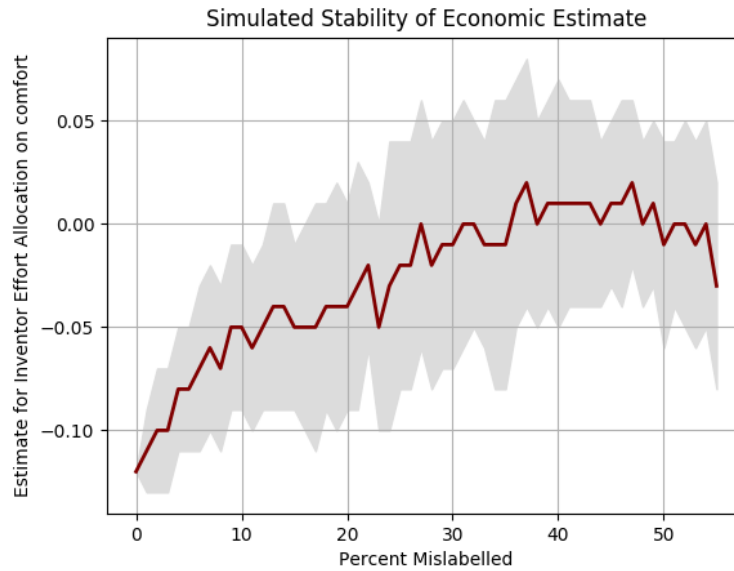

Panel B: Simplicity

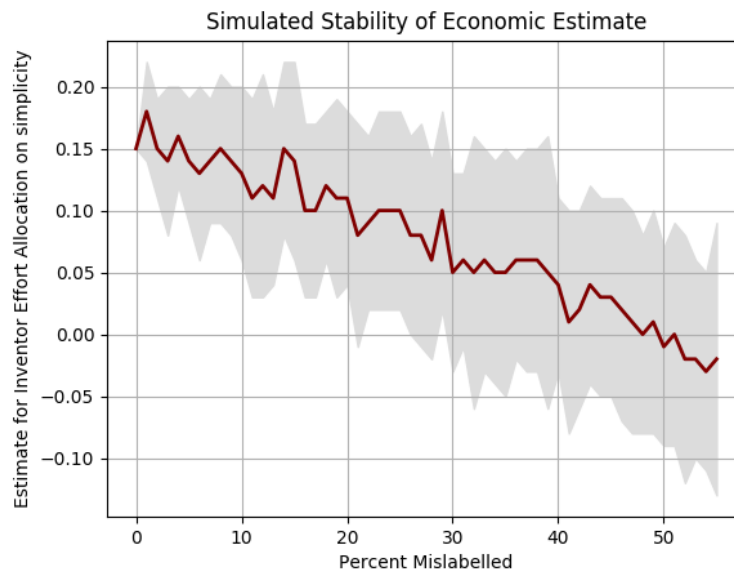

Note: The figure shows the simulated stability of our economic estimates as we reduce the accuracy of our preferred algorithm. Panel A shows the simulated stability for our “comfort” variable, and panel B shows the simulated stability of our “simplicity” variable. Using all the data generated by our preferred modified approach, we inject noise at random by altering the coding of a given percentage of the observations for our estimates of interest. We then re-estimate β_1 from equation (4) using a synthetic control procedure. We do this 40 times, sampling with replacement for each percent mislabeled. The red line in each panel traces the mean of the estimates of β_1 from equation (4) at each percent mislabeled. The shaded grey area shows one standard deviation above and below the mean.

Appendix Table B.1: Balanced Accuracy Scores Across Training and Test Set Contexts

Panel A: Comfort					
		Test Data			
		CWP	CWC	WWP	WWC
Training Data	CWP	93.9	84.4	91.8	78.4
	CWC	93.1	91.6	91.8	75.8
	WWP	93.6	84.4	92.7	78.4
	WWC	91.3	84.0	90.0	91.6

Panel B: Simplicity					
		Test Data			
		CWP	CWC	WWP	WWC
Training Data	CWP	97.0	86.0	94.8	89.1
	CWC	96.7	94.8	93.8	93.0
	WWP	95.8	86.0	94.8	89.1
	WWC	98.4	92.7	95.4	93.5

Note: The table shows the ability of our preferred modified approach applied to a GBM model to predict our traits within and outside the context of the model’s training data. We present balanced accuracy scores across wars and broad patent technological classes. Panel A shows the balanced accuracy scores when predicting “comfort,” and panel B shows the balanced accuracy scores when predicting “simplicity”. Balanced accuracy is reported in percentage terms (78.4 = 78.4% correctly predicted). The main diagonal presents the balanced accuracy means that are obtained through repeated 10-fold cross-validation, using the same context for training and testing. Off-diagonal entries present the model’s once-calculated balanced accuracy on the given left-out test set of a different context. The (i, j) entry corresponds to using the data from row header context i in GBM training to predict the left-out data from column header context j . CWP uses Civil War prosthesis patents, CWC uses Civil War control patents, WWP uses WWI prosthesis patents, and WWC uses the WWI control patents. To ensure that differences between balanced accuracy scores across contexts are not driven by differences in sample size, we constrain the size of the training set to be equal in all cases.

Appendix Table B.2: Performance of Algorithm Across Attributes Using All Patents

Characteristic	Sensitivity	Specificity	Balanced Accuracy
adjustability	94.8 (3.2)	91.0 (3.3)	92.9
comfort	91.8 (5.6)	96.3 (2.3)	94.0
simplicity	92.7 (5.3)	94.3 (2.6)	93.5
materials	81.6 (15.7)	92.4 (2.6)	87.0
appearance	91.8 (7.1)	96.1 (1.7)	93.9
cost	94.7 (4.3)	98.9 (1.1)	96.8

Note: The table shows the performance of our modified approach applied to a GBM algorithm across our traits of interest. We present the sensitivity (true-positive rate), specificity (true-negative rate), and the balanced accuracy (simple average of mean sensitivity and specificity). Sensitivity and specificity means are taken across repeated 10-fold cross-validation, and the corresponding standard errors are reported below each point estimate in parenthesis. All evaluation metrics and standard errors are reported in percentage terms (94.8 = 94.8% correctly predicted). All manually coded observations are used in the cross-validation procedure.

C Additional Discussion of the Synthetic Control Strategy for Analyzing Patent Traits

Table C.1 presents data on the baseline means for our patent trait variables for prosthetic devices, for the full sample of other medical and mechanical control classes, and the synthetic control group for each trait. The synthetic control procedure successfully brings the baseline means for the control groups much closer to the means for prosthetic devices. Notably, although the mean for appearance is matched quite closely for the World War I sample, the mean for the Civil War control group remains moderately below the mean for prosthetic devices. This reflects both the difficulty of matching quality-oriented traits and the moderate size of our samples of Civil War-era patents relative to World War I-era patents. Consequently, results for our analysis of appearance during the Civil War period ought to be interpreted with caution.

Tables C.2 and C.3 present the weights our synthetic control procedure assigns to the classes that contribute to each synthetic control group. We make several observations regarding the synthetic control weights. First, the synthetic control groups for our production process traits strike us as being reasonable. At the same time, they are not particularly illuminating. This is reassuring since, as noted above, improvements in the production process can be described using language that is common across mechanical and medical technologies, making the choice of control group relatively inconsequential. Second, the classes that form a synthetic control for “comfort” are quite intuitive. These classes include surgical categories, dentistry, and land vehicles. Third, the classes that form our Civil War synthetic control for “appearance” are superficially counterintuitive, as they include the category “Ammunition and explosive-charge making.” An inspection of the underlying patents, however, reveals that the relevant ammunition patents devote attention to the “finishing” process, which indeed denote improvements in prod-

uct appearance. Nonetheless, we take this as illustrative of the challenges of selecting control groups for a technology's quality-oriented attributes.

Appendix Table C.1: Baseline Summary Statistics for Prosthetic Devices, All Control Classes, and Re-Weighted Synthetic Control Classes

<i>Panel A: Civil War</i>	Prosthetics	All Controls	Synthetic Controls
production	0.188	0.227	0.189
usertraits	0.255	0.0694	0.245
cost	0.117	0.193	0.118
simplicity	0.102	0.185	0.11
adjustability	0.346	0.303	0.35
appliances	0	0.0445	
comfort	0.350	0.0685	0.346
appearance	0.415	0.0952	0.352
durability	0.730	0.622	0.729
materials	0.0327	0.0550	0.0328

<i>Panel B: World War I</i>	Prosthetics	All Controls	Synthetic Controls
production	0.318	0.355	0.318
usertraits	0.241	0.0778	0.241
cost	0.156	0.263	0.158
simplicity	0.363	0.391	0.362
adjustability	0.436	0.411	0.436
appliances	0.0744	0.0932	0.0744
comfort	0.426	0.0693	0.426
appearance	0.223	0.0708	0.222
durability	0.750	0.750	0.742
materials	0.0385	0.0585	0.0386

Note: This table presents baseline means for three samples, namely prosthetics, the “all controls” sample, and the “synthetic controls” sample. Panel A presents baseline means for the Civil War period, for which the baseline extends from 1855 to 1861. Panel B presents baseline means for the World War I period, for which the baseline extends from 1910 to 1915. The “all controls” sample consists of patents from all mechanical classes and all medical classes other than prosthetics. The “synthetic controls” sample was selected to match baseline prosthetics on their values across each year from 1855 to 1861 in panel A and across each year from 1910 to 1915 in panel B.

Appendix Table C.2: Civil War Synthetic Control Classes by Trait

Trait	Class Title	Class	Weight
Adjustability	Traversing Hoists	212	0.31
	Rotary Shafts, Gudgeons, Housings...	464	0.27
	Lubrication	184	0.19
	Optical: Systems And Elements	359	0.19
	Vehicle Fenders	293	0.04
Appearance	Land Vehicles: Bodies And Tops	296	0.56
	Ammunition And Explosive-Charge Making	86	0.36
	Severing By Tearing Or Breaking	225	0.08
Comfort	Advancing Material Of Indeterminate Length	226	0.5
	Ventilation	454	0.28
	Land Vehicles	280	0.09
	Surgery: Light, Thermal, And Electrical Application	607	0.07
Cost	Dentistry	433	0.06
	Elevator, Industrial Lift Truck, Or Stationary Lift...	187	0.49
	Ammunition And Explosive-Charge Making	86	0.26
	Abrading	451	0.22
Durability
	Metal Working	29	0.23
	Winding, Tensioning, Or Guiding	242	0.21
	Wireworking	140	0.2
Materials
	Railway Wheels And Axles	295	0.09
	Fluid Sprinkling, Spraying, And Diffusing	239	0.08
	Wood Turning	142	0.07
Production	Coopering	147	0.07

	Fasteners (Expanded, Threaded, Driven, etc.)	411	0.36
	Surgery: Light, Thermal, And Electrical Application	607	0.29
Simplicity	Endless Belt Power Transmission Systems...	474	0.11

	Optical: Systems And Elements	359	0.32
User	Ammunition And Explosive-Charge Making	86	0.29
	Railway Rolling Stock	105	0.17

User	Ventilation	454	0.85
	Cutters, For Shaping	407	0.15

Note: The table presents sets of synthetic control “donor” classes for each trait from our Civil War sample. Class numbers are from the United States Patent Classification (USPC) system. A synthetic control weight for each donor class is provided for each trait.

Appendix Table C.3: World War I Synthetic Control Classes by Trait

Trait	Class Title	Class	Weight
Adjustability	Photocopying	355	0.28
	Surgery	600	0.28
	Compound Tools	7	0.22
	Abrasive Tool Making Process...	51	0.22
Appearance	Plastic And Nonmetallic Article Shaping Or Treating Roll Or Roller	264	0.43
	Solid Anti-Friction Devices...	492	0.22
	Surgery: Light, Thermal, And Electrical Application	508	0.17
	Needle And Pin Making	607	0.1
		163	0.08
Appliances	Optics: Motion Pictures	352	0.48
	Wood Turning	142	0.16
	Optics: Image Projectors	353	0.13
	Alloys Or Metallic Compositions	420	0.11
Comfort	Surgery	128	0.67
	Ventilation	454	0.26
	Surgery: Light, Thermal, And Electrical Application	607	0.07
Cost	Selective Cutting (E.G., Punching)	234	0.55
	Sheet Feeding Or Delivering	271	0.35
	Surgery: Light, Thermal, And Electrical Application	607	0.08
	Roll Or Roller	492	0.02
		607	0.7
Durability	Surgery: Light, Thermal, And Electrical Application	607	0.7
	Rotary Kinetic Fluid Motors Or Pumps	415	0.3
Materials	Cutters, For Shaping	407	0.56
	Railway Wheels And Axles	295	0.23
	Conveyors, Chutes, Skids, Guides, And Ways	193	0.17
	Solid Anti-Friction Devices...	508	0.04
Production	Selective Cutting (E.G., Punching)	234	0.29
	Motors: Spring, Weight, Or Animal Powered	185	0.24
	Roll Or Roller	492	0.16
Simplicity
	Sheet-Material Associating	270	0.6
	Needle And Pin Making	163	0.18
	Lubrication	184	0.12
User
	Surgery: Light, Thermal, And Electrical Application	607	0.34
	Ventilation	454	0.29
	Surgery: Splint, Brace, Or Bandage	602	0.27
	Compound Tools	7	0.09

Note: The table presents sets of synthetic control “donor” classes for each trait from our World War I sample. Class numbers are from the United States Patent Classification (USPC) system. A synthetic control weight for each donor class is provided for each trait.

D Supplemental Analysis, Figures, and Tables

This appendix presents additional evidence on the effects of wartime demand on counts of medical innovation. First, Table D.1 presents estimates of equation (2). The estimates in table D.1 differ from the estimates in table 4 exclusively by model choice. That is, they are estimates of the Poisson model described by equation (2) rather than the OLS model described by equation (1). All estimates are between 0.54 and 0.88, suggesting that wartime demand shocks led to large increases in flows of prosthetic device patents. As in table 4, the estimates in panels B and C reveal economically larger increases during the Civil War than during World War I.

Second, figure D.1 presents estimates of the following event-study model:

$$E[N_{t,c}|X_t] = \exp(\gamma_{c,w} + \gamma_{t,w} + \sum_{t \neq 0} \beta_t 1\{\text{Prosthetic}\}_c \times 1\{\text{Year of War}\}_t + \varepsilon_{c,t}). \quad (\text{D.1})$$

In contrast with our estimates of equations (1) and (2), for which we collapsed the data into multi-year time periods, we estimate equation (D.1) using data that are collapsed at an annual frequency. In the summation, the omitted interaction between the prosthetic device indicator variable and the time dummy variables corresponds with the first full year of either the Civil War or World War I (i.e., the year for which $t = 0$ is the first full year of either war). Each β_t can thus be described as a difference-in-differences style estimate of the change in the prosthetic device patenting rate relative to patenting rates in the control categories from year t relative to the first full year of each war. In panel A, the control patent classes consist of all classes other than prosthetic devices that are either medical or mechanical classes. In panel B, the control patent classes are restricted to other medical classes. Standard errors are clustered at the patent class-by-war episode level. For reasons discussed in the main text, these standard errors are likely

to be insufficiently conservative, which motivates our use of randomization methods for inference when we assess the statistical significance of our primary estimates of interest.

The estimates trace out the differential changes one can observe through careful inspection of the time series in figure 1. Crucially, the point estimates associated with years prior to each war (i.e., $t < 0$) exhibit no discernable pattern that might be suggestive of a worrisome pre-existing trend. The point estimate for year $t = -1$ is fairly close to 0, is moderately smaller than the estimates for year $t = -2$ through $t = -5$, is moderately larger than the estimates for $t = -8$ through $t = -6$ and is economically indistinguishable from the estimate for years $t = -9$ through $t = -12$. Prosthetic device patenting exhibits a strong increase relative to the control categories across years $t = 1$ through $t = 7$. There is a notable peak in years $t = 3$ and $t = 4$, which correspond with the 4th and 5th full calendar years following the onset of each war.

Third, note that the standard errors are presented in parenthesis below the estimates in panel A of table 4 and table D.1 are conventional cluster-robust standard errors. Due to the small number of “treated patent class episodes” in our sample, however, conventional cluster-robust standard errors may result in insufficiently conservative inference (Bertrand, Duflo, and Mullainathan, 2004; Cameron, Gelbach, and Miller, 2008). In such settings, randomization inference has been found to generate p-values that confer appropriate degrees of statistical significance (Cameron, Gelbach, and Miller, 2008; Imbens and Rosenbaum, 2005). Figure D.3 displays our prosthesis point estimates (dashed vertical lines) in the context of distributions generated from three distinct randomization inference procedures.³⁹ In each case, the “true point estimate” is larger in magnitude

³⁹We use three distinct procedures for assigning placebo treatment status. In each case, we assign placebo treatment status to two patent class-by-episode observations. The sample from which these are drawn includes mechanical and medical patent classes other than prosthetic devices. For the first procedure (presented in panel A of figure D.3), we assign placebo treatment status at random across both treatment episodes. For the second (presented in panel B of figure D.3), we assign treatment at random to one patent class from each of the treatment episodes. For the third, we restrict the sample to patent classes that appear in both the Civil War and World War I sub-samples, then assign treatment at random

than nearly the entirety of the “placebo distribution.” One of the 500 estimates exceeds the true estimate when using assignment algorithm A, two when using algorithm B, and zero when using algorithm C. The implication, in each case, is that our estimates are statistically distinguishable from zero at the $p < .01$ level.

to a single patent class. The dispersion of the distributions of placebo point estimates is only modestly affected by these alternative assignment mechanisms.

Event Study Estimates

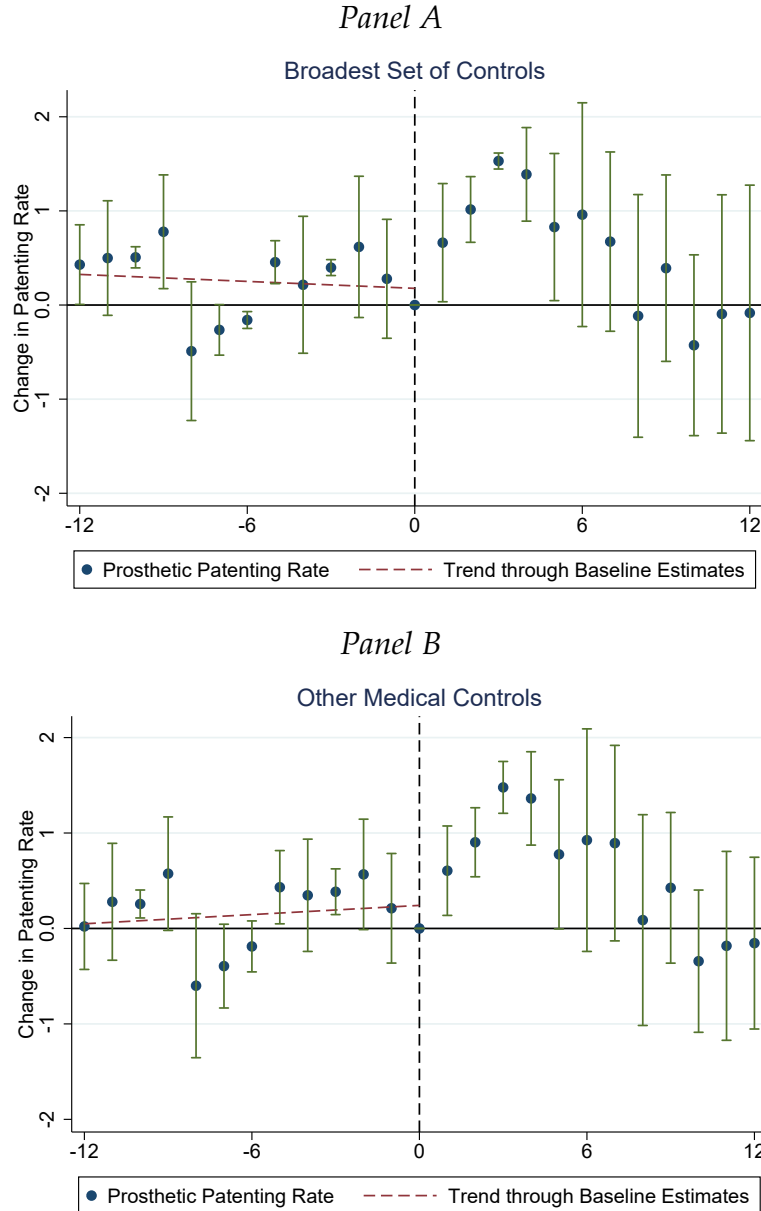

Appendix Figure D.1: Event Study Estimates of Changes in Prosthetic Device Patenting Rates During the Civil War and World War I

Note: The figure presents estimates of the β_t coefficients from equation (D.1). Data are analyzed at an annual frequency. The omitted year corresponds with the first full year of either the Civil War or World War I, such that each β_t can be described as a difference-in-differences style estimate of the change in the prosthetic device patenting rate relative to patenting rates in the control categories from year t relative to the first full year of each war. In panel A, the control patent classes consist of all classes other than prosthetic devices that are either medical or mechanical classes. In panel B, the control patent classes are restricted to other medical classes. Standard errors are clustered at the patent class-by-war episode level. For reasons discussed in the main text, these standard errors are likely to be insufficiently conservative, which motivates the use of randomization methods for inference when we assess the statistical significance of our primary estimates of interest.

Patents in Prosthetic Devices and Mechanical Classes

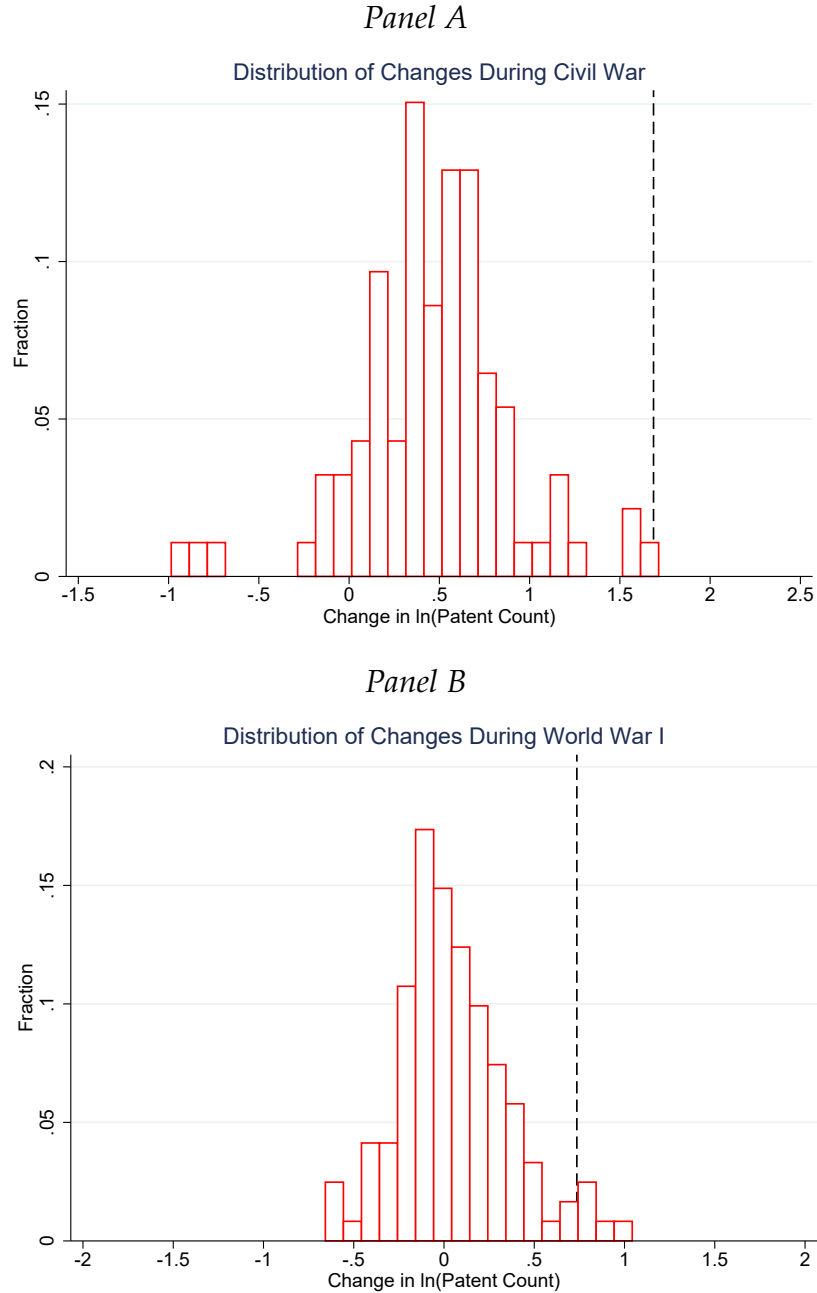

Appendix Figure D.2: Patents in Prosthetic Devices and Mechanical Classes

Note: This figure presents distributions of changes in the log of patents per year. Each data point in each distribution corresponds with a change for an individual USPTO class. The changes in panel A are calculated from a “base” period extending from 1855 to 1861 to a “war” period extending from 1862 to 1866. The changes in panel B are calculated from a “base” period extending from 1910 to 1915 to a “war” period extending from 1916 to 1922. The vertical dashed line in each panel corresponds with the change that occurred in USPTO class 623 “Prosthesis.”

Placebo Point Estimate Distributions across Three Algorithms

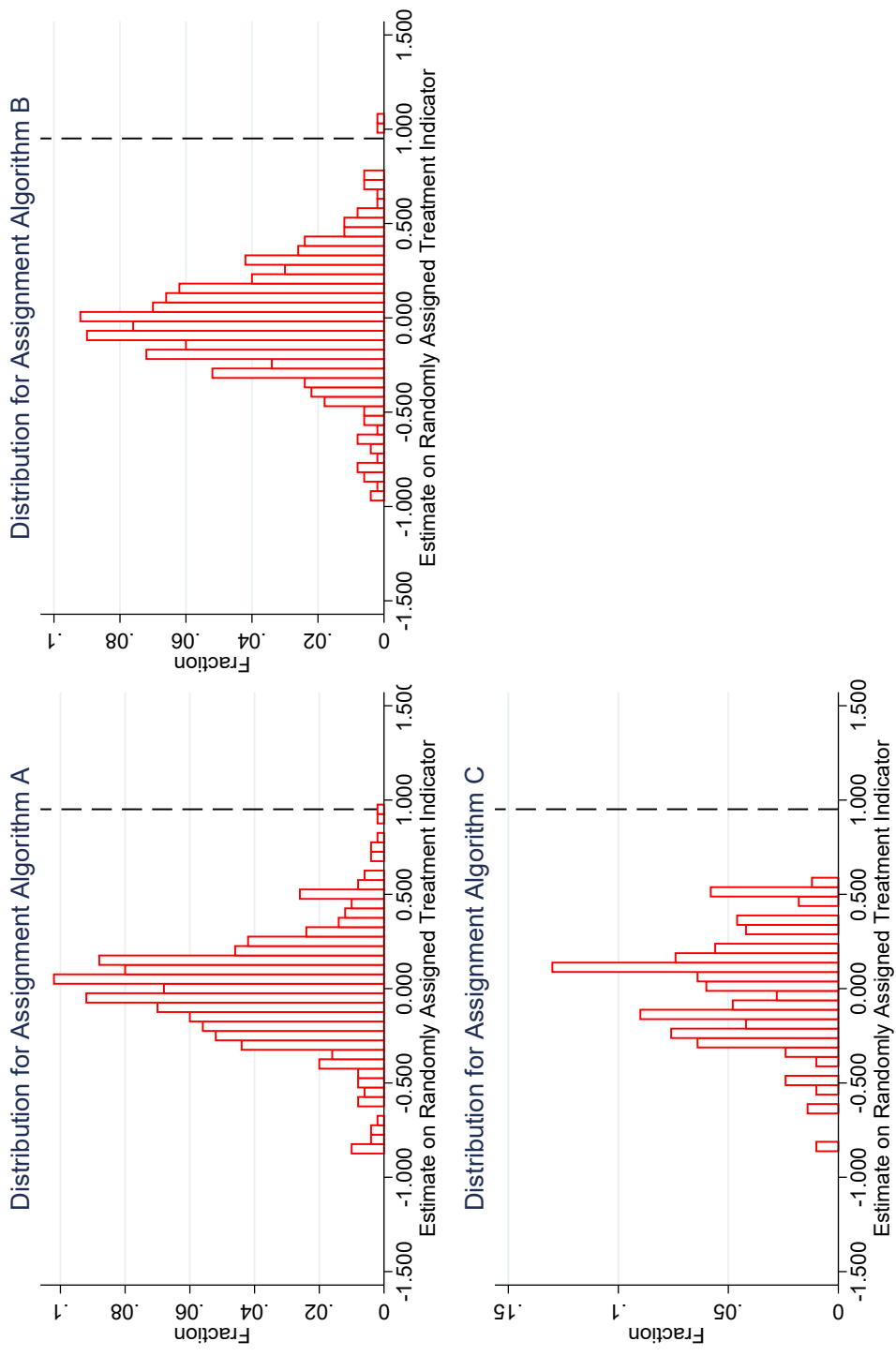

Appendix Figure D.3: Placebo Point Estimate Distributions across Three Algorithms

Note: The figure presents distributions of placebo point estimates generated through the application of a randomization inference procedure (Imbens and Rosenbaum, 2005). The distribution in each panel corresponds with a different algorithm for assigning placebo treatment status. In each case, we assign placebo treatment status to two patent class-by-episode observations. For observations associated with the Civil War, the pre-war period extends from 1855 to 1861, while the period over which the war influenced prosthetic device patenting is defined to extend from 1862 to 1866. For observations associated with World War I, the pre-war period extends from 1910 to 1915, while the period over which the war influenced prosthetic device patenting is defined to extend from 1916 to 1922. The sample from which these are drawn includes all mechanical and medical patent classes other than prosthetic devices. For Panel A, we assign placebo treatment status at random across this full set of episodes. For Panel B, we assign treatment at random to one patent class from each of the war episodes. For Panel C, we restrict the sample to patent classes that appear in both the Civil War and World War I sub-samples, then assign treatment at random to a single patent class. In each panel, the true estimate associated with assigning treatment status to “Prosthesis” is presented by the dashed vertical lines.

Mean Citations Per Patent

Panel A

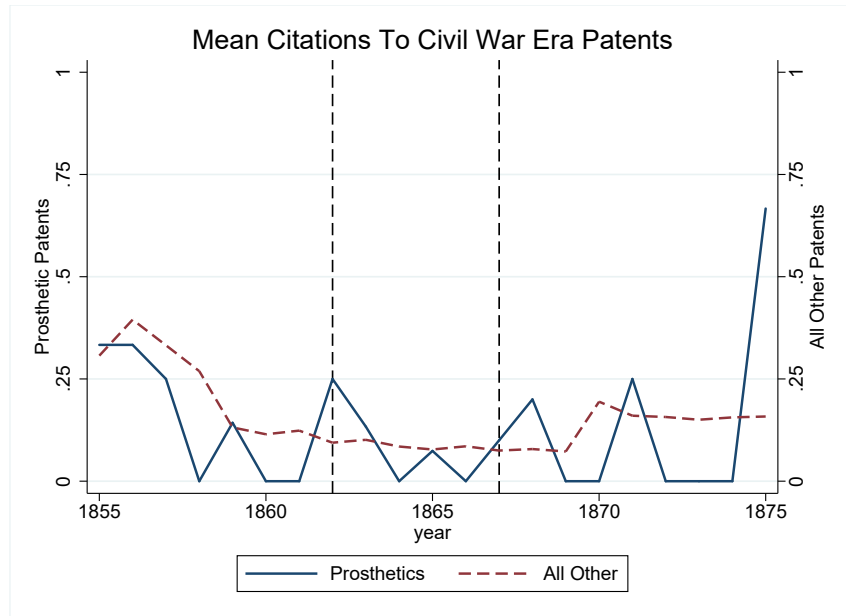

Panel B

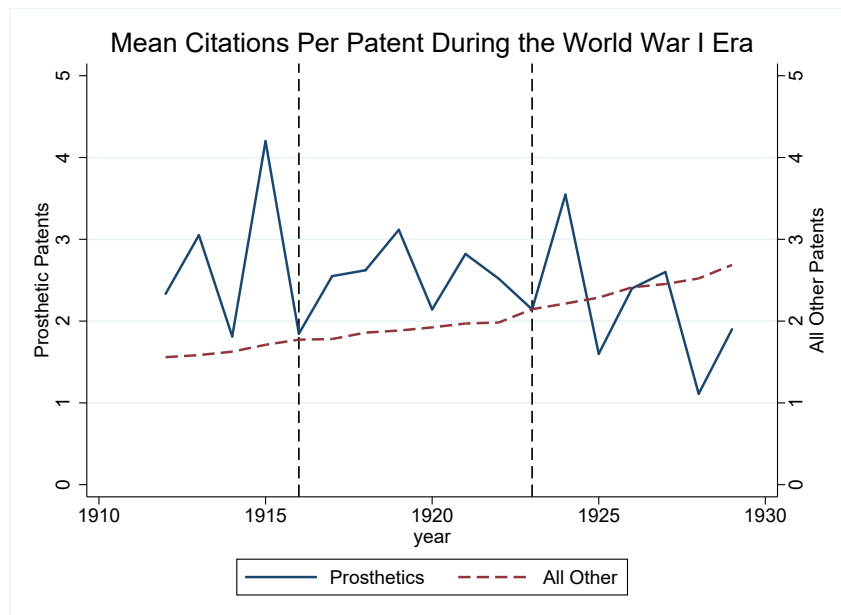

Appendix Figure D.4: Mean Citations Per Patent

Note: This figure presents time series on mean citations per patent. The data come from the citation files associated with comprehensive patent data from Berkes (2018). Citation data from the Civil War period are sparse because, as discussed by Berkes (2018), citations in patent documents, and by extension in the database, became more systematic and comprehensive over time. Dashed vertical lines indicate the periods we associate with wartime prosthetic device patenting, namely 1862 to 1866 during the Civil War and 1916 to 1922 during World War I.

Civil War Changes in the Cost-Oriented Traits: Prosthetic Legs vs. Arms

Panel A—Legs (Production)

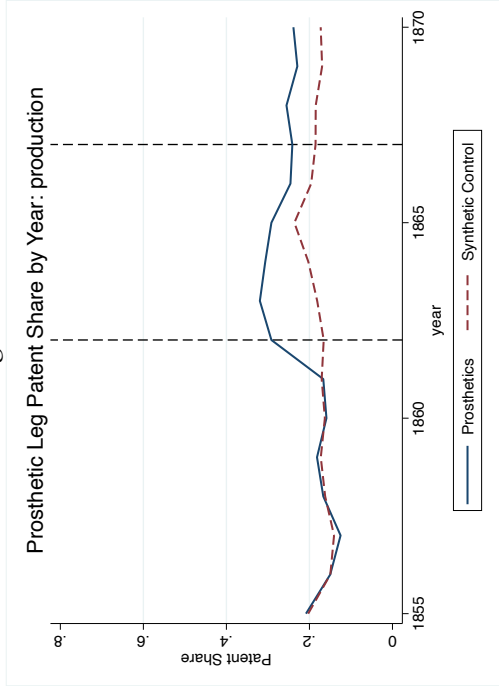

Panel B—Legs (Cost)

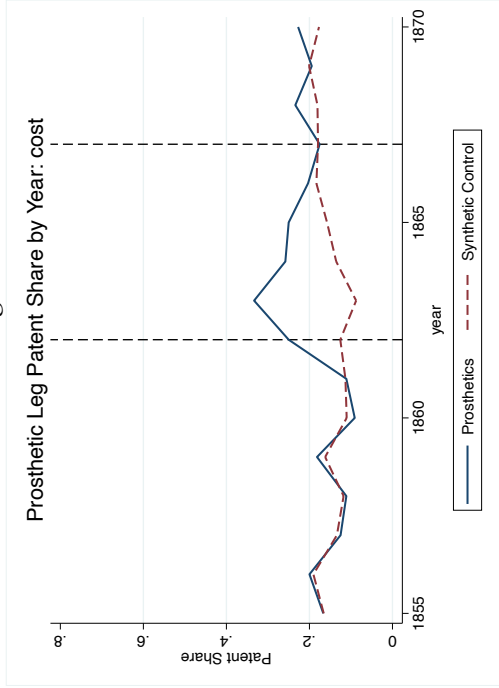

Panel C—Arms (Production)

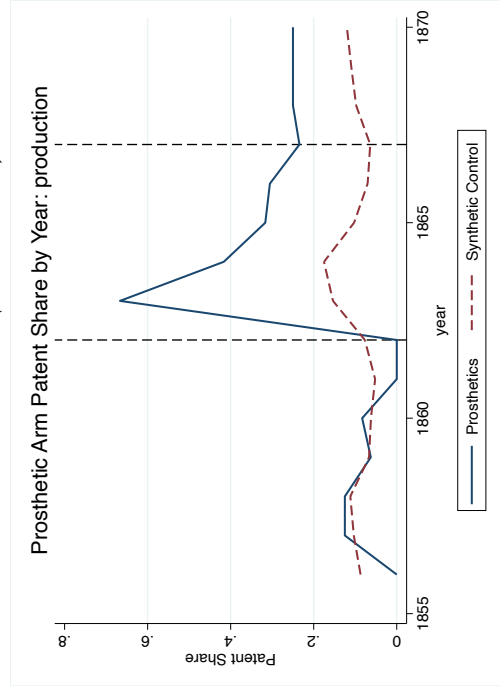

Panel D—Arms (Cost)

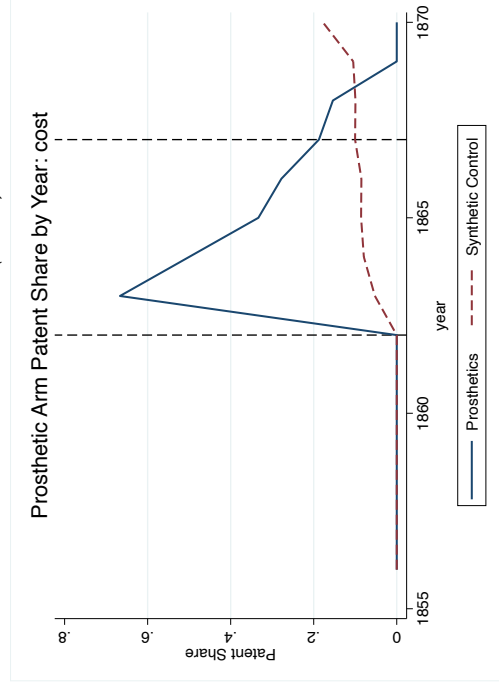

Appendix Figure D.5: Civil War Changes in the Cost-Oriented Traits: Prosthetic Legs vs. Arms Note: The figure presents data on the “treatment” and “synthetic control” series that describe the evolution of patents’ emphases across the “cost” trait and our aggregate “production” trait. The time series are calculated as 4-year moving averages. The series plot the share of patents in a given class (“Prosthesis” or the “Synthetic Control”) and prosthetic limb type (prosthetic leg or prosthetic arm) that emphasize a given trait. In Panels A and B, which represent changes in cost-oriented traits for prosthetic legs, the “Pre War” baseline extends from 1855 to 1861, and the “Wartime” period extends from 1862 to 1866. In Panels C and D, which represent changes in cost-oriented traits for prosthetic arms, the “Pre War” baseline extends from 1856 to 1861, and the “Wartime” period extends from 1862 to 1866. We generate the synthetic control group using the “synth” package written by Abadie and Hainmueller (2010). “Donor weights” are chosen to match the treatment group on values extending from 1855 to 1861 for Panels A and B, and from 1856 to 1862 for Panels C and D as the procurement program for prosthetic arms was officially implemented after the prosthetic leg program.

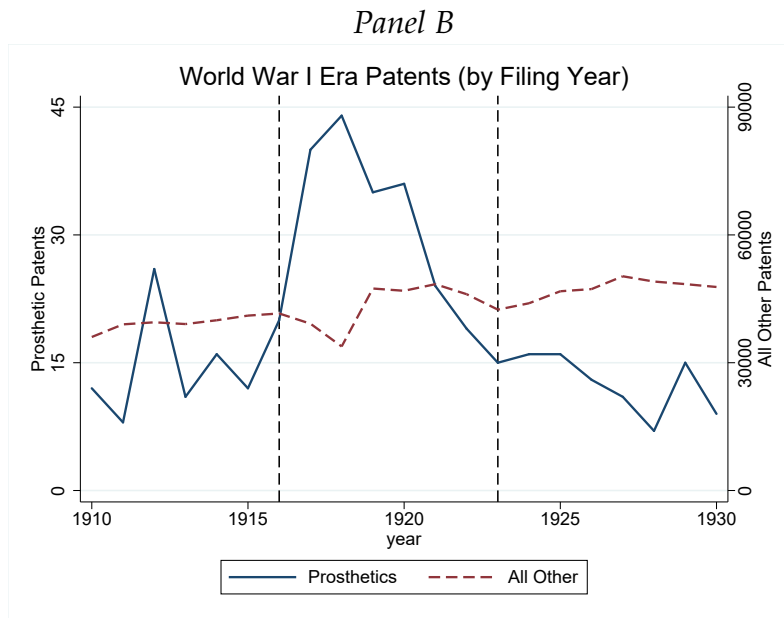
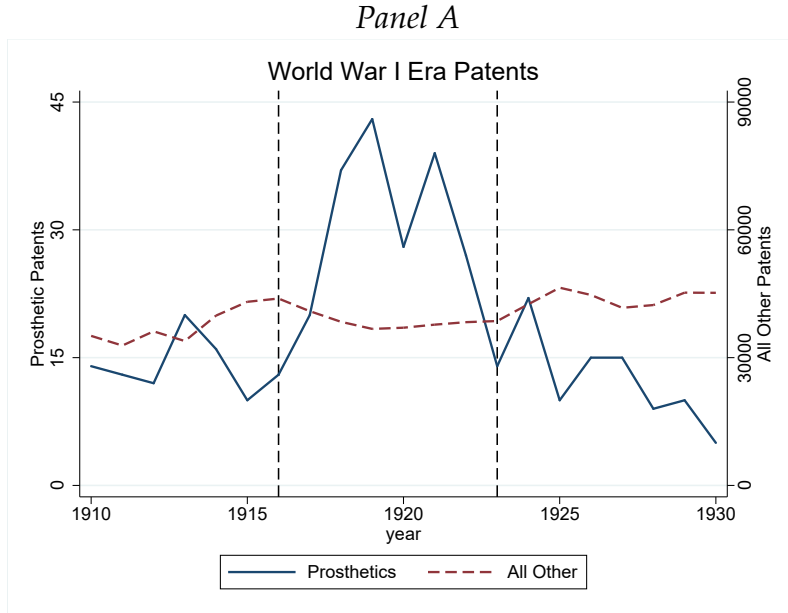

Appendix Figure D.6: Patent Time Series Note: This figure presents annual time series on patents, using USPTO categories as reported in Berkes (2018). In both panels, the solid blue line corresponds with patents from USPTO class 623 “Prosthesis.” In the top panel, the patents are organized in accordance with the year in which the patent was issued, while in the bottom panel, the patents are organized in accordance with the year in which the patent was filed.

Production Traits: Civil War Synthetic Controls

Panel A

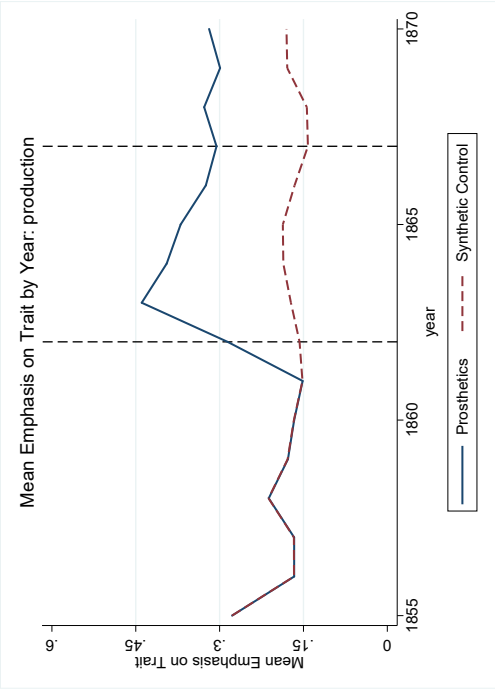

Panel B

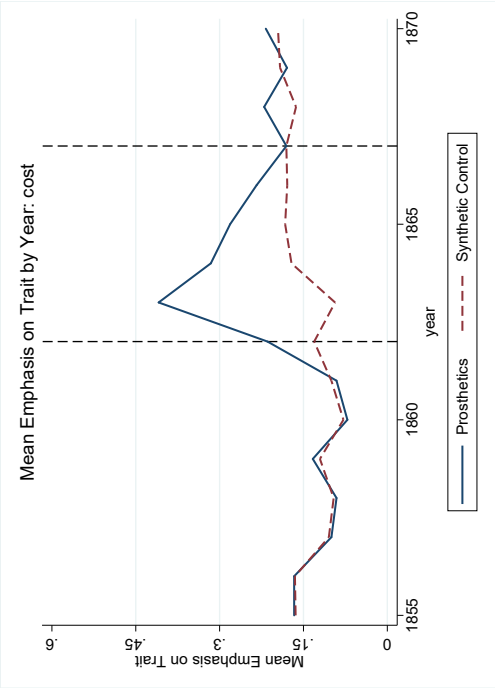

Panel C

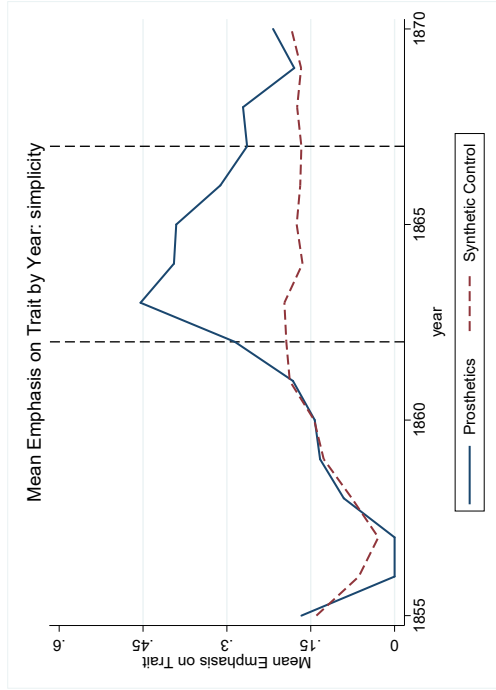

Panel D

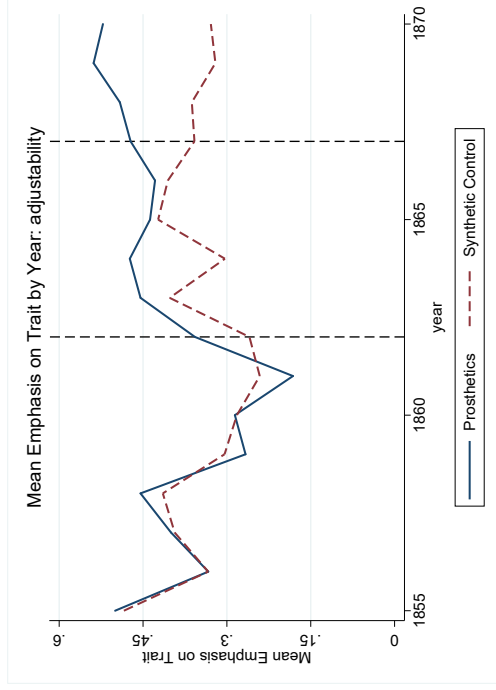

Appendix Figure D.7: Production Traits: Civil War Synthetic Controls

The figure presents the “treatment” and “synthetic control” series that describe the evolution of patents’ emphases on the traits we term “production,” “cost,” “simplicity,” and “adjustability.” Further information on the definitions of each trait can be found in table 3 as well as in the main text. All series in the figure are calculated as 4-year moving averages. The series plot the share of patents in a given class (“Prosthesis” or the “Synthetic Control”) that emphasize a given trait. We generate the synthetic control group using the “synth” package written by Abadie and Hainmueller (2010). “Donor weights” are chosen to match the treatment group on values extending from 1855 to 1861.

Production Traits: World War I Synthetic Controls

Panel A

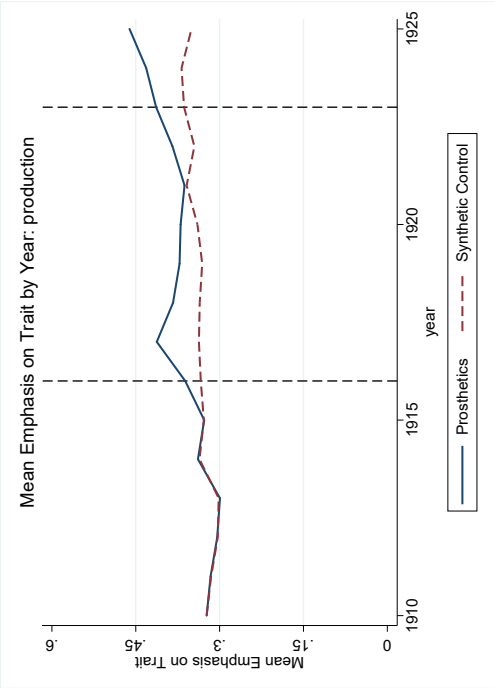

Panel B

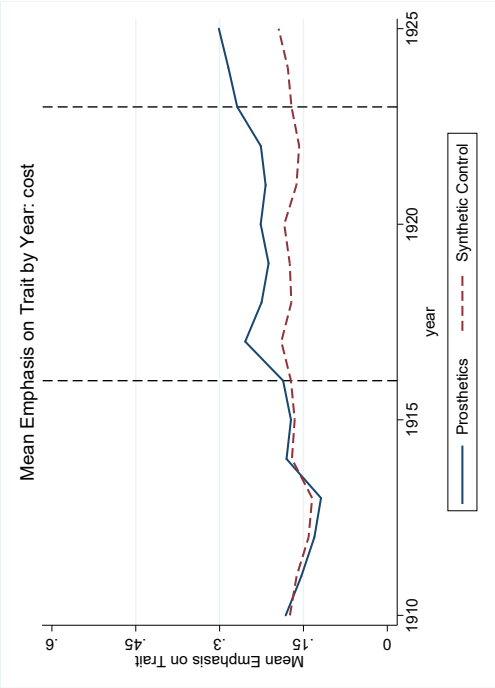

Panel C

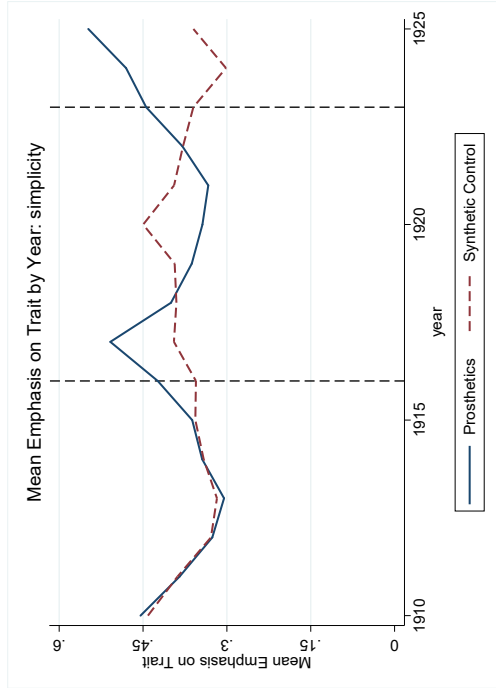

Panel D

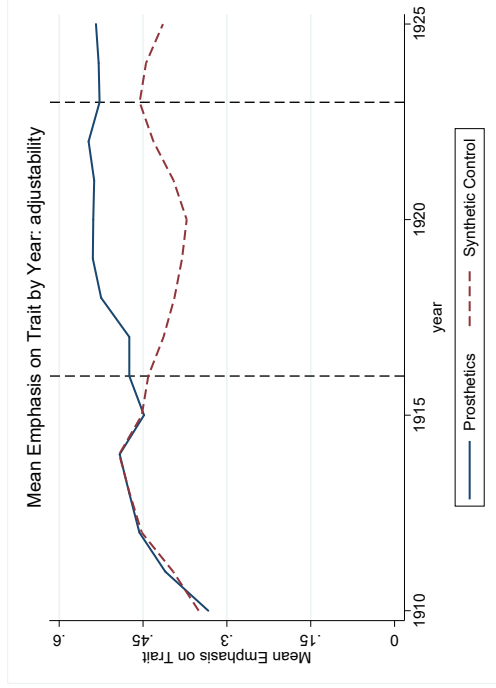

Appendix Figure D.8: Production Traits: World War I Synthetic Controls

Note: The figure presents the “treatment” and “synthetic control” series that describe the evolution of patents’ emphases on the traits we term “production,” “cost,” “simplicity,” and “adjustability.” Further information on the definitions of each trait can be found in table 3 as well as in the main text. All series in the figure are calculated as 4-year moving averages. The series plot the share of patents in a given class (“Prosthesis” or the “Synthetic Control”) that emphasize a given trait. We generate the synthetic control group using the “synth” package written by Abadie and Hainmueller (2010). “Donor weights” are chosen to match the treatment group on values extending from 1910 to 1915.

User Traits: Civil War Synthetic Controls

Panel A

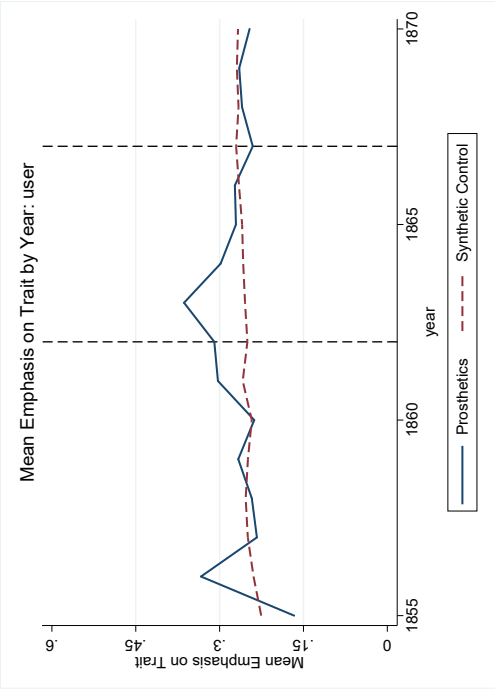

Panel B

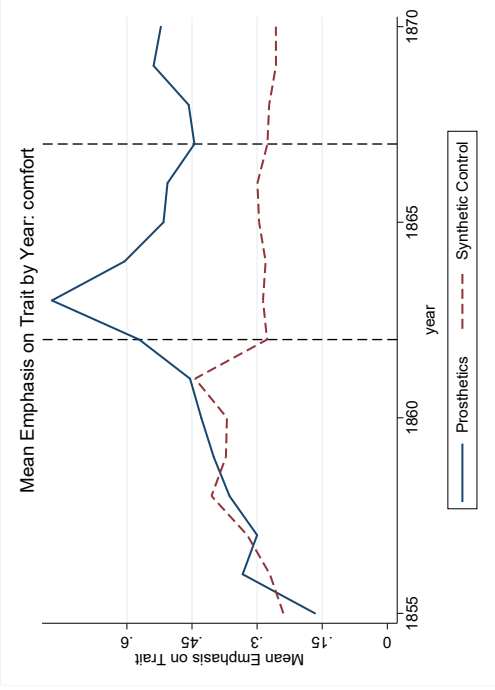

Panel C

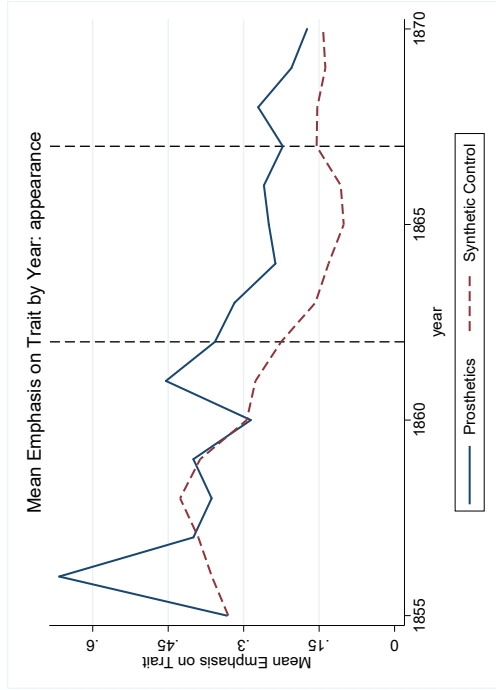

Appendix Figure D.9: User Traits: Civil War Synthetic Controls

Note: The figure presents the “treatment” and “synthetic control” series that describe the evolution of patents’ emphases on the traits we term “user traits,” “comfort,” and “appearance.” Further information on the definitions of each trait can be found in table 3 as well as in the main text. All series in the figure are calculated as 4-year moving averages. The series plot the share of patents in a given class (“Prosthesis” or the “Synthetic Control”) that emphasize a given trait. We generate the synthetic control group using the “synth” package written by Abadie and Hainmueller (2010). “Donor weights” are chosen to match the treatment group on values extending from 1855 to 1861.

User Traits: World War I Synthetic Controls

Panel A

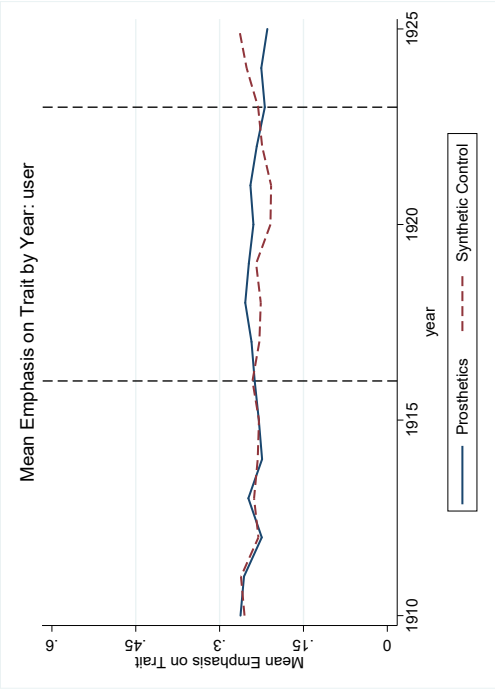

Panel B

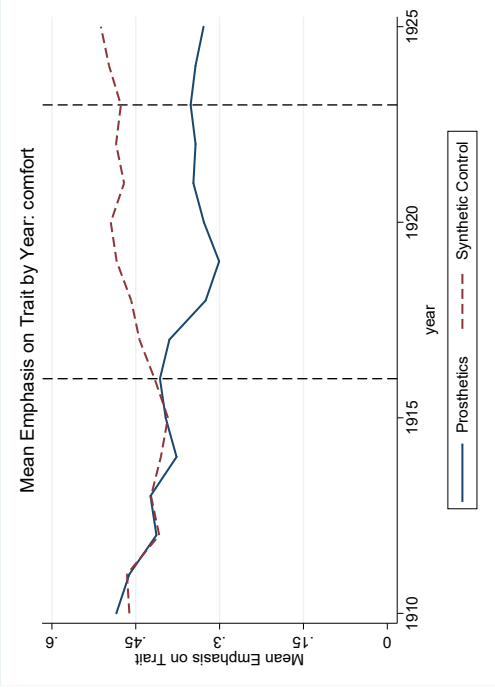

Panel C

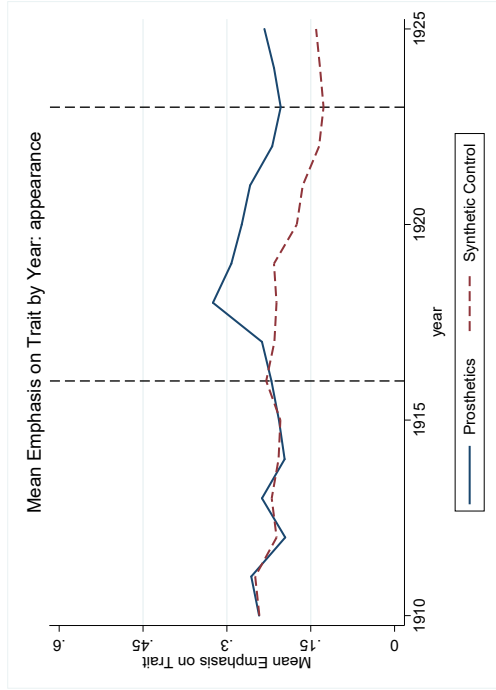

Panel D

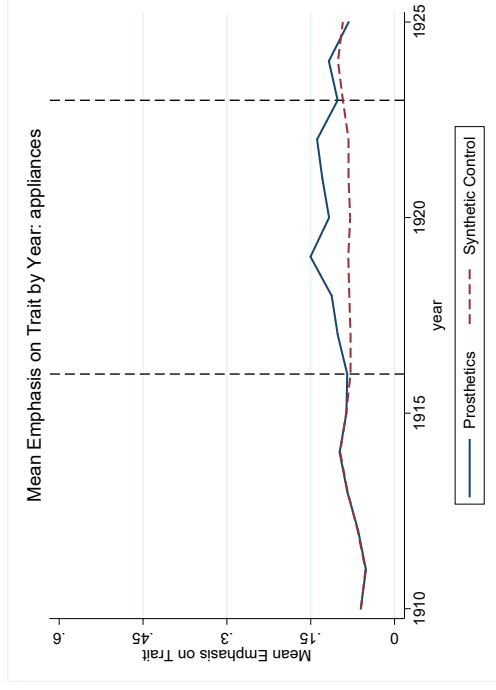

Appendix Figure D.10: User Traits: World War I Synthetic Controls

Note: The figure presents the “treatment” and “synthetic control” series that describe the evolution of patents’ emphases on the traits we term “user traits,” “comfort,” “appearance,” and “appliances.” Further information on the definitions of each trait can be found in table 3 as well as in the main text. All series in the figure are calculated as 4-year moving averages. The series plot the share of patents in a given class (“Prosthesis” or the “Synthetic Control”) that emphasize a given trait. We generate the synthetic control group using the “synth” package written by Abadie and Hainmueller (2010). “Donor weights” are chosen to match the treatment group on values extending from 1910 to 1915.

Materials and Durability: Civil War and World War I Synthetic Controls

Panel A

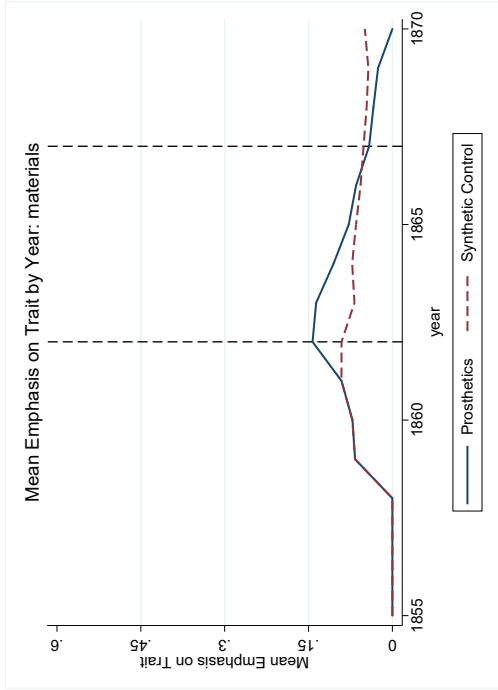

Panel B

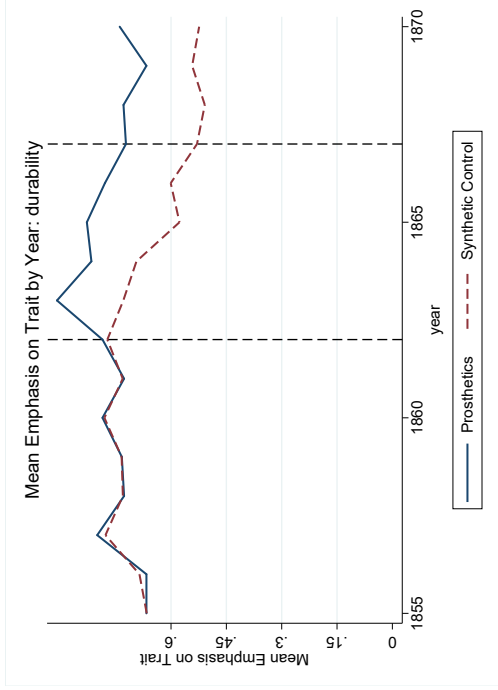

Panel C

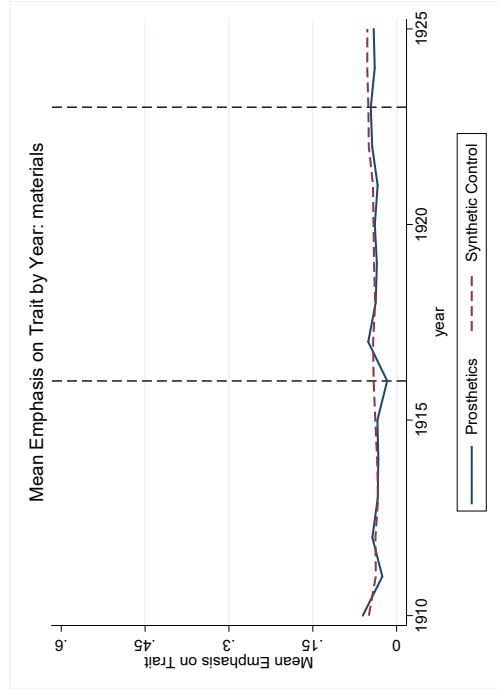

Panel D

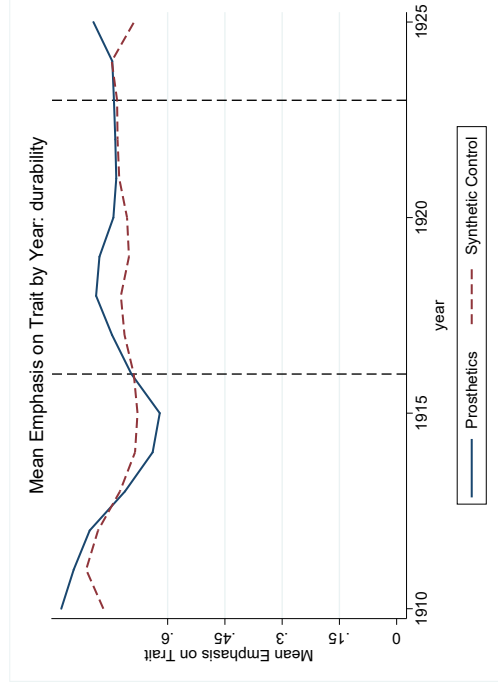

Appendix Figure D.11: Materials and Durability: Civil War and World War I Synthetic Controls

Note: The figure presents the “treatment” and “synthetic control” series that describe the evolution of patents’ emphases on the traits we term “materials” and “durability.” Further information on the definitions of each trait can be found in table 3 as well as in the main text. All series in the figure are calculated as 4-year moving averages. The series plot the share of patents in a given class (“Prosthesis” or the “Synthetic Control”) that emphasize a given trait. We generate the synthetic control group using the “synth” package written by Abadie and Hainmueller (2010). “Donor weights” for panels C and D are chosen to match the treatment group on values extending from 1855 to 1861. “Donor weights” for panels A and B are chosen to match the treatment group on values extending from 1910 to 1915.

Appendix Table D.1: Relative Increases in Prosthetic Device Patenting During the Civil War and World War I

	(1)	(2)	(3)	(4)	(5)	(6)	(7)
	All Cntrls	Matched	Medical	Misc. Mech.	Metal	Mater. Proc.	Non War
<i>Panel A: Full Sample</i>							
Prosthetics x War	0.812 (0.142)	0.542 (0.175)	0.797 (0.097)	0.776 (0.119)	0.818 (0.153)	0.879 (0.194)	0.808 (0.147)
N	432	88	34	128	56	92	362
Clusters	216	44	17	64	28	46	181
Estimator	Poisson	Poisson	Poisson	Poisson	Poisson	Poisson	Poisson
Class-by-Episode FE	Yes	Yes	Yes	Yes	Yes	Yes	Yes
Period Effects	Yes	Yes	Yes	Yes	Yes	Yes	Yes
SEs in Parentheses	Clustered	Clustered	Clustered	Clustered	Clustered	Clustered	Clustered
Randomization Inf.	P < .01	P < .01	P < .01	P < .01	P < .01	P < .01	P < .01
<i>Panel B: Civil War</i>							
Prosthetics x War	1.233	0.529	1.134	1.110	1.251	1.436	1.243
Randomization Inf.	P < .01	P < .01	P < .01	P < .01	P < .01	P < .01	P < .01
N	188	88	14	56	24	42	156
<i>Panel C: WWI</i>							
Prosthetics x War	0.681	0.409	0.711	0.677	0.687	0.699	0.673
Randomization Inf.	P < .05	P < .2	P < .01	P < .03	P < .01	P < .01	P < .04
N	244	32	20	72	32	50	206

Note: The table presents estimates of equation (2). The control group used for each regression is described in the column heading. The sample for Panel A includes both the Civil War and World War I episodes, while the sample for Panel B consists solely of the Civil War episode and the sample for Panel C consists solely of the World War I episode. For observations associated with the Civil War, the pre-war period extends from 1855 to 1861, while the period over which the war influenced prosthetic device patenting is defined to extend from 1862 to 1866. For observations associated with World War I, the pre-war period extends from 1910 to 1915, while the period over which the war influenced prosthetic device patenting is defined to extend from 1916 to 1922. In Panel A, the standard errors reported in parentheses allow for clusters at the patent class-by-war episode level. In each panel, the p-values reported in rows labeled "Randomization Inf" are based on the position of the point estimate in the distribution of placebo point estimates that are constructed using a procedure along the lines recommended by Imbens and Rosenbaum (2005). Additional details are reported in the main text.

Appendix Table D.2: Hand-Coded Training Set Tabulations

	(1)	(2)		(3)	(4)
		Civil War		World War I	
		Prosthetics	Controls	Prosthetics	Controls
production	0.243	0.226	0.226	0.360	0.356
user	0.346	0.0501	0.0501	0.295	0.0475
cost	0.174	0.231	0.231	0.235	0.302
simplicity	0.226	0.148	0.148	0.394	0.380
adjustability	0.328	0.301	0.301	0.450	0.387
comfort	0.497	0.0551	0.0551	0.371	0.0426
appearance	0.195	0.0451	0.0451	0.219	0.0525
durability	0.687	0.363	0.363	0.384	0.269
materials	0.0462	0.0551	0.0551	0.0530	0.0852
Observations	195	399	399	302	305

Note: The table presents sample means for the patents in our hand-coded training data set. For the complete hand-coded data set, the patents in the Civil War sample extend from 1840 to 1890, while the patents in the World War I sample extend from 1890 to 1940.

Appendix Table D.3: Full Sample Tabulations

	(1)	(2)	(3)	(4)
	Civil War		World War I	
	Prosthetics	Controls	Prosthetics	Controls
production	0.285	0.257	0.378	0.377
user	0.256	0.0562	0.257	0.0784
cost	0.186	0.200	0.245	0.299
simplicity	0.247	0.223	0.405	0.426
adjustability	0.423	0.350	0.484	0.407
appliances	0.0515	0.0568	0.0855	0.0797
appearance	0.222	0.0605	0.276	0.0741
comfort	0.495	0.0513	0.410	0.0813
durability	0.753	0.624	0.747	0.786
materials	0.0464	0.0319	0.0435	0.0611
Observations	194	151038	620	593706

Note: The table presents sample means for all the “treatment” and “control” patents in the data set we generate using machine learning methods. For the complete data set, the patents in the Civil War sample extend from 1840 to 1890, while the patents in the World War I sample extend from 1890 to 1940.

Appendix Table D.4: Correlations across Patent Attributes

	cost	simplicity	adjustability	appliances	appearance	comfort	durability	materials
cost	1.0000							
simplicity	0.3746	1.0000						
adjustability	0.0512	0.0392	1.0000					
appliances	0.0485	0.0654	0.0040	1.0000				
appearance	0.0568	-0.0151	0.0088	0.0568	1.0000			
comfort	0.0893	-0.0183	0.0684	-0.1123	0.1296	1.0000		
durability	0.1165	0.1192	-0.0045	-0.0014	0.0508	0.0980	1.0000	
materials	0.0523	0.0096	-0.0107	-0.0399	0.0887	0.1028	0.0009	1.0000

Note: The table presents a simple correlation matrix across the economic traits we have defined and coded. The sample underlying the matrix is the sample of prosthetic device patents extending from 1840 to 1940.

Appendix Table D.5: Hand-Coded Training Set Tabulations and Changes

	(1)	(2)	(3)	(4)	(5)	(6)	(7)
	Prosthetics		Other Mechanical		Differences		
<i>Panel A: Civil War</i>	Pre-Boom	Boom	Pre-Boom	Boom	Prosth. Diff	Other Diff	Diff-in-Diff
production	0.0952	0.313	0.218	0.284	0.218	0.0665	0.151
user	0.381	0.364	0.0413	0.0902	-0.0168	0.0488	-0.0656
cost	0.0952	0.247	0.231	0.279	0.152	0.0473	0.104
simplicity	0.0476	0.321	0.132	0.230	0.273	0.0973	0.176
adjustability	0.143	0.370	0.289	0.344	0.228	0.0550	0.173
comfort	0.381	0.506	0.0413	0.0492	0.125	0.00786	0.117
appearance	0.381	0.222	0.0413	0.131	-0.159	0.0898	-0.249
durability	0.714	0.654	0.264	0.508	-0.0600	0.244	-0.304
materials	0.0476	0.0741	0.0826	0.0492	0.0265	-0.0335	0.0599
<i>Panel B: World War I</i>	Pre-Boom	Boom	Pre-Boom	Boom	Prosth. Diff	Other Diff	Diff-in-Diff
production	0.325	0.372	0.329	0.384	0.0465	0.0556	-0.00909
user	0.347	0.271	0.0436	0.0533	-0.0765	0.00971	-0.0862
cost	0.188	0.237	0.248	0.360	0.0485	0.112	-0.0632
simplicity	0.365	0.406	0.369	0.393	0.0411	0.0242	0.0169
adjustability	0.424	0.473	0.369	0.400	0.0499	0.0309	0.0190
comfort	0.506	0.319	0.0537	0.0333	-0.187	-0.0204	-0.167
appearance	0.188	0.222	0.0336	0.0733	0.0340	0.0398	-0.00579
durability	0.318	0.396	0.235	0.300	0.0785	0.0651	0.0134
materials	0.0353	0.0628	0.0671	0.107	0.0275	0.0396	-0.0120

Note: The table presents sets of means and changes in means for our hand-coded training data set. The means in columns 1 through 4 are calculated separately for baseline prosthetics, wartime prosthetics, baseline controls, and wartime controls. As in our regressions, the Civil War baseline corresponds with 1855 to 1861, while the World War I baseline extends from 1910 to 1915. The Civil War “wartime” period corresponds with 1862 to 1866, while the World War I “wartime” period extends from 1916 to 1922. Column 5 presents the change from baseline to wartime for prosthetics, while column 6 presents the change from baseline to wartime for the controls. Column 7 presents the difference between these differences.

Appendix Table D.6: Full Sample Tabulations and Changes

	(1)	(2)	(3)	(4)	(5)	(6)	(7)
	Prosthetics		Other Mechanical		Differences		
<i>Panel A: Civil War</i>	Pre-Boom	Boom	Pre-Boom	Boom	Prosth. Diff	Other Diff	Diff-in-Diff
production	0.159	0.346	0.252	0.241	0.187	-0.0114	0.198
user	0.270	0.276	0.0507	0.0482	0.00588	-0.00254	0.00842
cost	0.0952	0.247	0.197	0.187	0.152	-0.0105	0.162
simplicity	0.0952	0.333	0.213	0.218	0.238	0.00543	0.233
adjustability	0.286	0.457	0.347	0.318	0.171	-0.0291	0.200
appliances	0	0.0494	0.0403	0.0477	0.0494	0.00742	0.0420
appearance	0.429	0.247	0.0682	0.0547	-0.182	-0.0135	-0.168
comfort	0.381	0.531	0.0436	0.0420	0.150	-0.00151	0.151
durability	0.762	0.778	0.638	0.611	0.0159	-0.0274	0.0433
materials	0.0476	0.0741	0.0356	0.0376	0.0265	0.00205	0.0244
<i>Panel B: World War I</i>	Pre-Boom	Boom	Pre-Boom	Boom	Prosth. Diff	Other Diff	Diff-in-Diff
production	0.318	0.391	0.360	0.371	0.0737	0.0108	0.0629
user	0.247	0.240	0.0641	0.0721	-0.00712	0.00804	-0.0152
cost	0.153	0.232	0.270	0.294	0.0789	0.0238	0.0551
simplicity	0.353	0.396	0.412	0.429	0.0432	0.0167	0.0265
adjustability	0.447	0.546	0.397	0.389	0.0988	-0.00807	0.107
appliances	0.0706	0.135	0.0699	0.0784	0.0647	0.00857	0.0561
appearance	0.224	0.256	0.0566	0.0639	0.0325	0.00739	0.0251
comfort	0.447	0.329	0.0658	0.0739	-0.119	0.00815	-0.127
durability	0.694	0.758	0.765	0.772	0.0643	0.00784	0.0565
materials	0.0353	0.0435	0.0419	0.0467	0.00818	0.00483	0.00336

Note: The table presents sets of means and changes in means for the full data set we generate using machine learning methods. The means in columns 1 through 4 are calculated separately for baseline prosthetics, wartime prosthetics, baseline controls, and wartime controls. As in our regressions, the Civil War baseline corresponds with 1855 to 1861, while the World War I baseline extends from 1910 to 1915. The Civil War “wartime” period corresponds with 1862 to 1866, while the World War I “wartime” period extends from 1916 to 1922. Column 5 presents the change from baseline to wartime for prosthetics, while column 6 presents the change from baseline to wartime for the controls. Column 7 presents the difference between these differences.

Appendix Table D.7: Tabulations and Changes with Medical Control Classes Only

	(1)	(2)		(3)		(4)		(5)		(6)		(7)
	Prosthetics		Other Mechanical		Differences							
<i>Panel A: Civil War</i>	Pre-Boom	Boom	Pre-Boom	Boom	Pre-Boom	Boom	Prosth. Diff	Other Diff	Prosth. Diff	Other Diff	Diff-in-Diff	
production	0.159	0.346	0.207	0.237	0.187	0.0296	0.157	0.0296	0.187	0.0296	0.157	
user	0.270	0.276	0.137	0.110	0.00588	-0.0268	0.0326	-0.0268	0.00588	-0.0268	0.0326	
cost	0.0952	0.247	0.0962	0.142	0.152	0.0460	0.106	0.0460	0.152	0.0460	0.106	
simplicity	0.0952	0.333	0.128	0.213	0.238	0.0850	0.153	0.0850	0.238	0.0850	0.153	
adjustability	0.286	0.457	0.397	0.355	0.171	-0.0421	0.213	-0.0421	0.171	-0.0421	0.213	
appliances	0	0.0494	0.0192	0.0305	0.0494	0.0112	0.0382	0.0112	0.0494	0.0112	0.0382	
appearance	0.429	0.247	0.0833	0.0609	-0.182	-0.0224	-0.159	-0.0224	-0.182	-0.0224	-0.159	
comfort	0.381	0.531	0.308	0.239	0.150	-0.0691	0.219	-0.0691	0.150	-0.0691	0.219	
durability	0.762	0.778	0.526	0.533	0.0159	0.00735	0.00852	0.00735	0.0159	0.00735	0.00852	
materials	0.0476	0.0741	0.0577	0.0508	0.0265	-0.00693	0.0334	-0.00693	0.0265	-0.00693	0.0334	

	<i>Panel B: World War I</i>		Pre-Boom		Boom		Prosth. Diff		Other Diff		Diff-in-Diff
	Pre-Boom	Boom	Pre-Boom	Boom	Prosth. Diff	Other Diff	Prosth. Diff	Other Diff	Prosth. Diff	Other Diff	Diff-in-Diff
production	0.318	0.391	0.354	0.364	0.0737	0.00988	0.0737	0.00988	0.0737	0.00988	0.0638
user	0.247	0.240	0.161	0.170	-0.00712	0.00991	-0.00712	0.00991	-0.00712	0.00991	-0.0170
cost	0.153	0.232	0.251	0.271	0.0789	0.0199	0.0789	0.0199	0.0789	0.0199	0.0591
simplicity	0.353	0.396	0.388	0.410	0.0432	0.0222	0.0432	0.0222	0.0432	0.0222	0.0210
adjustability	0.447	0.546	0.424	0.412	0.0988	-0.0124	0.0988	-0.0124	0.0988	-0.0124	0.111
appliances	0.0706	0.135	0.141	0.154	0.0647	0.0127	0.0647	0.0127	0.0647	0.0127	0.0520
appearance	0.224	0.256	0.113	0.118	0.0325	0.00432	0.0325	0.00432	0.0325	0.00432	0.0282
comfort	0.447	0.329	0.227	0.240	-0.119	0.0128	-0.119	0.0128	-0.119	0.0128	-0.131
durability	0.694	0.758	0.651	0.675	0.0643	0.0245	0.0643	0.0245	0.0643	0.0245	0.0399
materials	0.0353	0.0435	0.0616	0.0881	0.00818	0.0265	0.00818	0.0265	0.00818	0.0265	-0.0183

Note: The table presents sets of means and changes in means for our full data set, but with the control group restricted to medical patent classes only. The means in columns 1 through 4 are calculated separately for baseline prosthetics, wartime prosthetics, baseline controls, and wartime controls. As in our regressions, the Civil War baseline corresponds with 1855 to 1861, while the World War I baseline extends from 1910 to 1915. The Civil War “wartime” period corresponds with 1862 to 1866, while the World War I “wartime” period extends from 1916 to 1922. Column 5 presents the change from baseline to wartime for prosthetics, while column 6 presents the change from baseline to wartime for the controls. Column 7 presents the difference between these differences.

Appendix Table D.8: Crude Matching Sample Tabulations and Changes

	(1)	(2)	(3)	(4)	(5)	(6)	(7)
	Prosthetics		Other Mechanical		Differences		
<i>Panel A: Civil War</i>	Pre-Boom	Boom	Pre-Boom	Boom	Prosth. Diff	Other Diff	Diff-in-Diff
production	.159	.346	.179	.221	.187	.0423	.145
user	.27	.276	.239	.176	.00588	-.0629	.0688
cost	.0952	.247	.115	.139	.152	.0241	.128
simplicity	.0952	.333	.119	.231	.238	.112	.126
adjustability	.286	.457	.281	.286	.171	.00436	.167
appearance	.429	.247	.423	.0936	-.182	-.329	.147
comfort	.381	.531	.357	.379	.15	.0223	.128
durability	.762	.778	.746	.715	.0159	-.0314	.0473
materials	.0476	.0741	.0374	.0373	.0265	-.000149	.0266
<i>Panel B: World War I</i>	Pre-Boom	Boom	Pre-Boom	Boom	Prosth. Diff	Other Diff	Diff-in-Diff
production	.318	.391	.335	.352	.0737	.0171	.0565
user	.247	.24	.252	.251	-.00712	-.000115	-.00701
cost	.153	.232	.177	.219	.0789	.0419	.0371
simplicity	.353	.396	.37	.399	.0432	.0295	.0137
adjustability	.447	.546	.444	.437	.0988	-.00689	.106
appliances	.0706	.135	.0489	.0553	.0647	.00632	.0584
appearance	.224	.256	.214	.183	.0325	-.0316	.0641
comfort	.447	.329	.42	.417	-.119	-.00372	-.115
durability	.694	.758	.692	.708	.0643	.0154	.0489
materials	.0353	.0435	.0309	.0383	.00818	.00736	.000821

Note: The table presents sets of means and changes in means for data sets in which the control group is constrained using a simple matching procedure. Specifically, the control group is selected to include all control-group patent classes for which the baseline mean is within 6 percentage points of the mean for prosthetic devices for a given economic trait. The one exception is “comfort” during the World War I episode, for which the control-group patent classes consist of those for which the baseline mean is within 20 percentage points of the mean for prosthetic devices. This reflects the fact that there were no close matches for prosthetic devices with respect to “comfort” during the World War I period. The means in columns 1 through 4 are calculated separately for baseline prosthetics, wartime prosthetics, baseline controls, and wartime controls. As in our regressions, the Civil War baseline corresponds with 1855 to 1861, while the World War I baseline extends from 1910 to 1915. The Civil War “wartime” period corresponds with 1862 to 1866, while the World War I “wartime” period extends from 1916 to 1922. Column 5 presents the change from baseline to wartime for prosthetics, while column 6 presents the change from baseline to wartime for the controls. Column 7 presents the difference between these differences.